



*An Online CPD Course
brought to you by
CEDengineering.ca*

Overview of Electric Overhead Traveling (EOT) Cranes

Course No: D06-003
Credit: 6 PDH

A. Bhatia



Continuing Education and Development, Inc.

P: (877) 322-5800
info@cedengineering.ca

OVERVIEW
OF
ELECTRIC OVERHEAD TRAVELING (EOT) CRANES



CONTENTS

PART – 1: General Overview

- ❖ Introduction
- ❖ Type of Overhead Cranes
- ❖ Components of Bridge Crane
- ❖ Essential Terminology when Specifying Overhead Cranes

PART- 2: Classification of Cranes

- ❖ Crane Duty Groups
- ❖ CMAA Service Classification
- ❖ HMI/ASME Hoist Duty Ratings
- ❖ FEM Service Classification
- ❖ Comparison between different Standards
- ❖ Crane Speeds

PART- 3: Hoists

- ❖ Hoists Types
- ❖ Hoists Lifting Media – Chains or Ropes
- ❖ Hoist Selection Factors
- ❖ Components of Hoisting Equipment
- ❖ Safety Features
- ❖ Hoist Standards

PART- 4: Structural Design Considerations

- ❖ Crane Runway
- ❖ Crane Loads on the Runway Girder
- ❖ Design of Crane Runway Girder
- ❖ Typical Profile of Crane Girder
- ❖ Crane Runway Girder and the Building Structure

- ❖ Crane Rails, Stops and Bumpers

PART- 5: Crane Electrification & Power Supply

- ❖ Methods of Crane Electrification
- ❖ Bridge and Runway Electrification
- ❖ Festoon Systems
- ❖ Motors and Controllers
- ❖ Enclosures – NEMA Standards
- ❖ Electrical Grounding
- ❖ Control Systems

PART- 6: Design Specifications

- ❖ Specifications and Codes
- ❖ Structural Requirements
- ❖ Mechanical Requirements
- ❖ Electrical & Control Requirements

PART- 7: Inspection & Testing Requirements

- ❖ Key Crane Inspection Areas
- ❖ OSHA Inspection Requirements
- ❖ Testing Requirements

Appendix – A: KEY WORDS AND DEFINITIONS

Appendix – B: STEEL BUILDING USING CRANE – GLOSSARY OF TERMS

Appendix – C: INTERNATIONAL CODES, STANDARDS AND REGULATIONS

5. How high must the hoist lift?
6. Is the bridge going to be supported by the building, self-supported, or both?
7. Is the bridge going to be indoors or outdoors?
8. How is the crane powered? All motorized push-pull, hand geared, or combination?
9. If motorized, how fast? Single or dual speeds? Variable frequency drives?
10. What voltages are required?
11. What type of control? Pendant from hoist, separate track or remote control?
12. Any special features? Cabs, walkways, horns, lights?
13. What specifications, codes or local regulations are applicable?

We will address all these aspects in this course.

TYPES OF ELECTRIC OVERHEAD CRANES

There are various types of overhead cranes with many being highly specialized, but the great majority of installations fall into one of four categories:

1. **Single Girder Cranes** - The crane consists of a single bridge girder supported on two end trucks. It has a trolley hoist mechanism that runs on the bottom flange of the bridge girder.
2. **Double Girder Bridge Cranes** - The crane consists of two bridge girders supported on two end trucks. The trolley runs on rails on the top of the bridge girders.
3. **Gantry Cranes** - These cranes are essentially the same as the regular overhead cranes except that the bridge for carrying the trolley or trolleys is rigidly supported on two or more legs running on fixed rails or other runways. These “legs” eliminate the supporting runway and column system and run on a rail either embedded in, or laid on top of the floor.
4. **Monorail** - For some applications such as production assembly line or service line, only a trolley hoist is required. This type of crane is designed

using I-beams like those found in ceiling structures of many factories. The trolleys run along the flat surface on the bottom horizontal bars of the beam. The hoisting mechanism is similar to a single girder crane with the difference that the crane doesn't have a movable bridge and the hoisting trolley runs on a fixed girder.

Which Crane should you choose – Single Girder or Double Girder

Based on the CMAA (Crane Manufacturers Association of America) specifications, both single and double girder cranes are equally rigid, strong, and durable. The principle difference between single and double girder cranes is *hook height* (how far above the floor your hoist will lift). Double girder cranes typically allow 18-36 inches higher lift, because the hoist is placed between the cross girders rather than under them. Therefore, the depth of the cross girder is gained in switching to double girders.

Cost Considerations

Single girder cranes may cost less for several reasons:

- Only one girder is required
- The trolley is simpler
- Freight expenses are reduced
- Installation is faster
- Runway beams are lighter

However, not all cranes should be designed with a single girder. *Generally, if the crane has to handle more than 15 ton or the span is more than 80 feet, a double girder crane is a preferred option.* Double girder cranes are also highly suitable where the crane needs to be fitted with walkways, cabs, magnet cable reels or other special equipment.

The Crane Manufacturers Association of America (CMAA) is pretty much the head kahuna of the US crane industry. Every reputable crane builder conforms to CMAA Spec 70 (for double girder cranes) or CMAA Spec 74 (for single girder cranes).

Crane Configurations

1. Under Running (U/R)
2. Top Running (T/R)

Under running cranes

Under running or under slung cranes are supported by using a suspension type support which is connected to the bottom of the frame. The crane wheels are supported from the bottom of flange of the crane beams which act as a crane rail and usually only span a portion of the column-to-column span of the structure. Under running cranes are typically available in standard capacities up to 10 tons (special configurations up to 25 tons and over 90 ft spans). Under hung cranes offer excellent side approaches, close headroom and can be supported on runways hung from existing building members if adequate.

The under running crane offers the following advantages:

- Very small trolley approach dimensions meaning maximum utilization of the building's width and height.
- The possibility of using the existing ceiling girder for securing the crane track.

The following are some limitations to under running cranes:

- Hook Height - Due to the location of the runway beams, hook height is reduced
- Roof Load - The load being applied to the roof is greater than that of a top running crane
- Flange Loading - Lower flange loading of runway beams require careful sizing; otherwise, you can "peel" the flanges off the beam

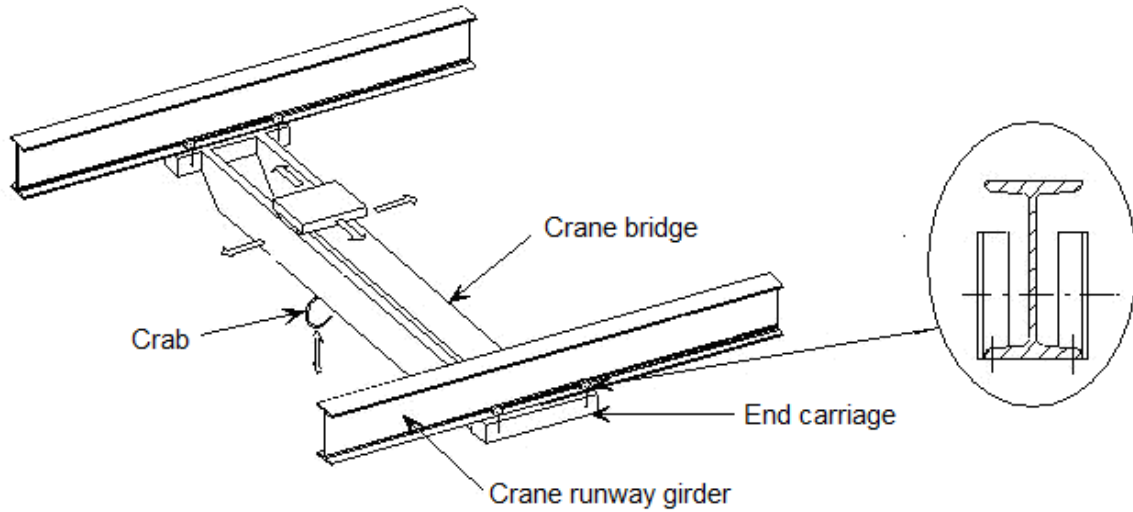

UNDERSLUNG BRIDGE CRANE

Top Running Cranes

The crane bridge travels on top of rails mounted on a runway beam supported by either the building columns or columns specifically engineered for the crane. Top running cranes are the most common form of crane design where the crane loads are transmitted to the building columns or free standing structure. These cranes have the greatest variation in capacity, span and service class and usually span the full width of the framing supports. These are available in both single girder and double girder configuration.

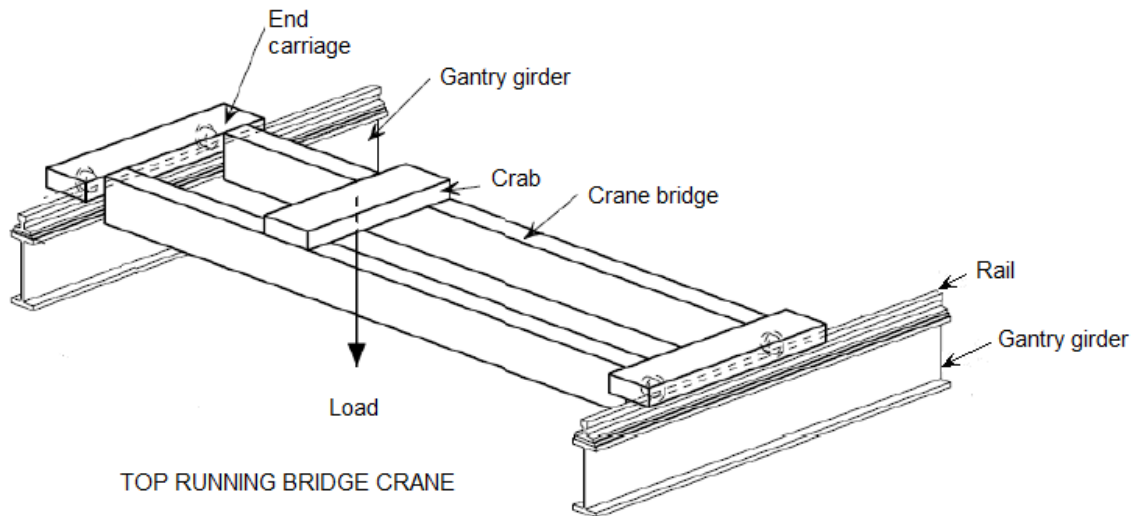

TOP RUNNING BRIDGE CRANE

COMPONENTS OF BRIDGE CRANES

The function of a crane is to move the lifted load horizontally and longitudinally in the building. The lifted load is usually supported with a hook which is cabled to a hoist. The hoist is supported by a trolley which moves horizontally along the crane bridge. The crane bridge is connected to a number of crane trucks at each end depending on the capacity and span. The crane trucks can have 2, 4 or 8 wheels based on the capacity of the crane. The wheels ride along a crane rail which is supported by runway beams. The figure below illustrates the basic crane components;

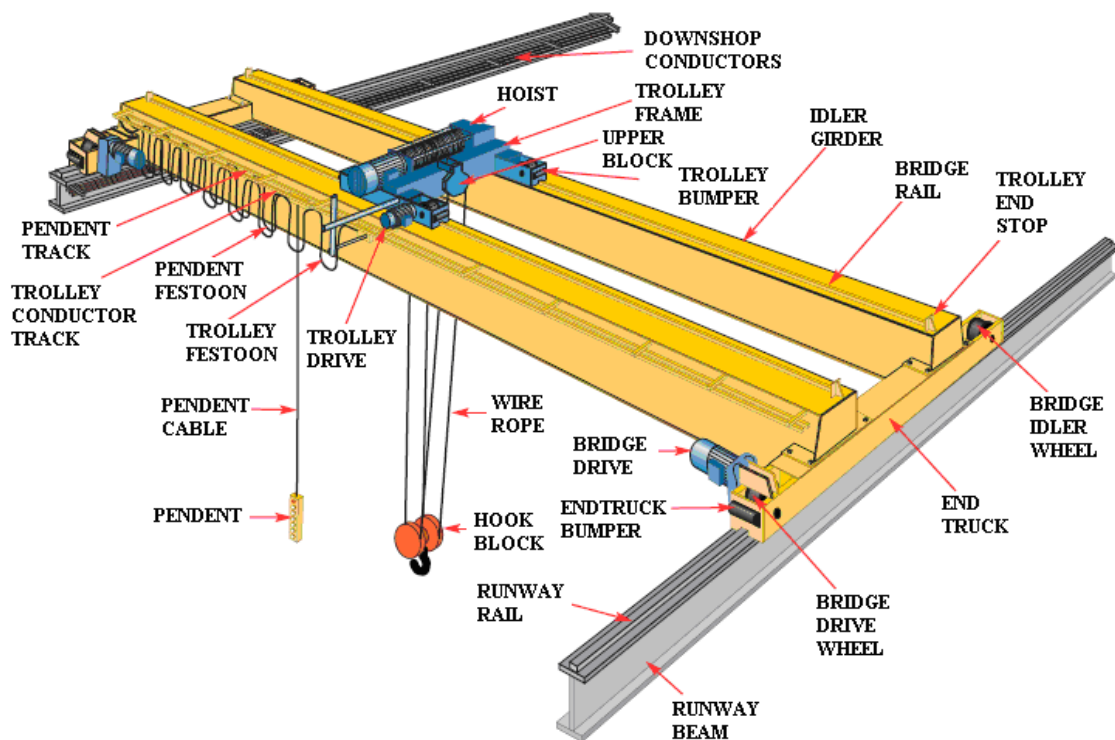

TOP RUNNING DOUBLE GIRDER CRANE

1. **Bridge** - The Bridge is the principal structural component of an overhead crane. It spans the width of the building and comprises one or more load bearing beams or girders. These may be fabricated steel box-girders or rolled-steel joists. The bridge carries the hoist trolley, which travels along the length of the girders during operation.

2. **Runway** - The track and support system on which the crane operates. The runway girders are usually considered a part of the building structure and are designed accordingly.
3. **Runway Rail** - The rail supported by the runway beams on which the crane travels.
4. **End trucks** - Located on either side of the bridge, the end trucks house the wheels on which the entire crane travels. It is an assembly consisting of structural members, wheels, bearings, axles, etc., which supports the bridge girder(s) or the trolley cross member(s). Electric drive motors typically two-speed or variable-speed units power the wheels and move the crane into the required position. Brakes are mounted on the drive motors and are essential to prevent uncontrolled loads becoming dangerous, and are often electrically operated. Electrical limit switches cut power to the drive motors and prevent the crane from colliding with the building structure at the end of the travel range.
5. **Hoist** - The hoist mechanism is a unit consisting of a motor drive, coupling, brakes, gearing, drum, ropes, and load block designed to raise, hold and lower the maximum rated load. The hoist mechanism is mounted to the trolley.
6. **Trolley or Crab** - The 'crab' is the 'cross travel unit' from which the hook is lowered and raised. A top-running trolley on a double girder crane runs on rails fitted to the top of the crane bridge. An underhung trolley on a single-girder crane runs on the bottom flange of the crane beam, with drive units connected directly to the trolley. The trolley carries the electric wire rope hoist that supports the load block and hook through a system of pulleys. A variable-speed AC motor on the hoist drives the load up or down. Limit switches prevent the load block from colliding with the trolley.
7. **Bumper (Buffer)** - An energy absorbing device intended for reducing impact when a moving crane or trolley reaches the end of its permitted travel, or when two moving cranes or trolleys come into contact. This device may be attached to the bridge, trolley or runway stop.

- Controls** - Controls for an EOT crane are usually mounted in an operator pendant or remote console and comprise various push buttons and switches that operate relays and contactors mounted on the crane. Drive motors and the hoist motor draw substantial currents during operation and require appropriately rated contactors to switch them on and off. Variable frequency inverters provide speed control for motors where accurate positioning is essential. A master contactor is triggered by a main switch and cuts off all power to the crane if a dangerous situation occurs.

Other features on specialized cranes may include: end stops, provision of a full length platform on both girders, provision of under bridge lighting, and provision of a closed, glazed or air conditioned cabin, specialized controls, etc.

ESSENTIAL TERMINOLOGY WHEN SPECIFYING OVERHEAD CRANES

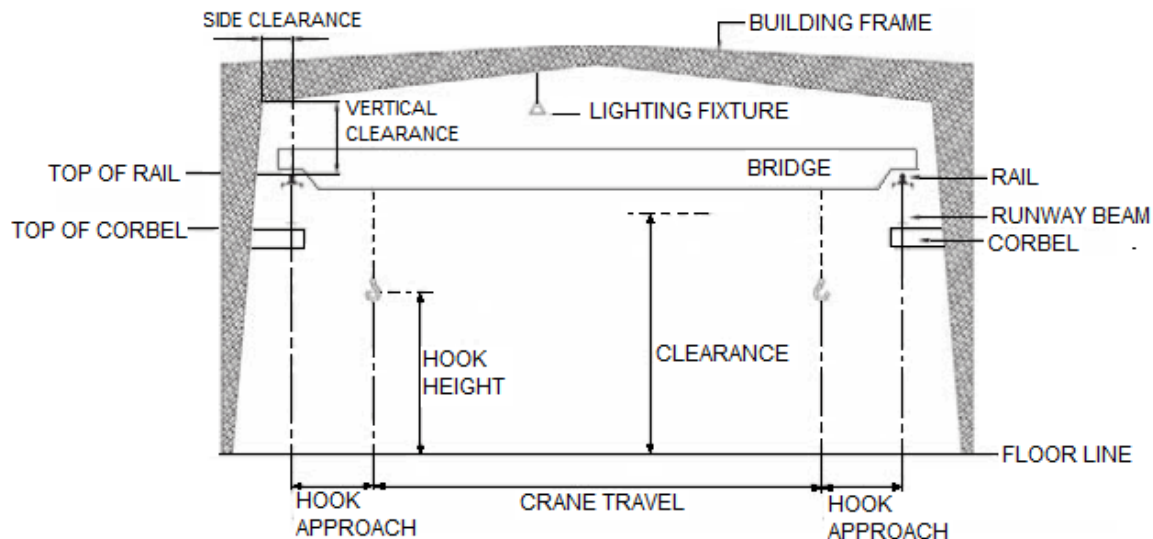

- Crane Capacity** - The rated capacity of crane is the maximum working load that can be lifted. A crane capacity is expressed in US tons or (metric) tonnes and is required by code to be marked on each side of the crane and hoist; and if the crane has more than one hoisting unit, each hoist shall have its rated load marked on it. Note that the load block, hook and ropes are not included in the rated load. If the crane is intended to be used along with a magnet, 'C' hook, grab, ladle or any other appliance,

the dead weight of such appliance should be specified so that the safe working load of the crane could be determined appropriately.

Note: The regulations set forth by OSHA 1910.179 N paragraph (k) states that the crane shall not be loaded beyond its rated load except for test purposes. The load test shall be conducted at or near 125% of the rated load.

Caution: Never pick more than the rated working load limit (WLL) since so many factors go into the design of a crane and one has to look at the safety factor of all the components such as the wire rope, the motors, bearings, sheaves, drums, wheels, rails, hoisting speeds, and beam and steel sizes. In many cranes this will be printed as the safe working load (SWL).

2. **Long travel** - 'Long travel' is the direction of travel of the bridge along the rails.
3. **Cross travel** - 'Cross travel' is the movement of the 'crab' from one side of the bridge to the other.
4. **Hook Height** - The hook height is the distance from the datum to the highest position of the hook. This dimension is critical in most applications as it determines the height of the runway from the floor and is dependent on the clear inside height of the building. Effective lift is the distance between the beam and the floor, minus the height of the hoist.
5. **Runway Height** - The distance between the grade level and the top of the rail.
6. **Side Clearances** - Side clearances are measured from the center of the supporting rail to the face of the supporting column and are required for operation, safety and wheel maintenance.
7. **Vertical Clearances** - The crane must be able to travel within the building while avoiding obstructions in the building such as lights, equipment and structural framing. The vertical clearance is based on the size of the crane bridge, location of the hoist and trolley, rail and safety

- allowance. The lower the crane headroom is, the higher will be the vertical clearance and the lower could be the building height.
8. **Clear Span** - The span of the crane is the horizontal center distance between the rails of the runway on which the crane is to travel. Typically the distance is approximately 500 mm less than the width of the building. How much span a crane requires depends on the crane coverage width dictated by the application. Crane coverage is the horizontal crane coverage and is defined as the crane span less the left side hook approach and right side hook approach.
 9. **Runway Length** - The longitudinal run of the runway rail parallel to the length of the building.
 10. **Hook approaches** - The maximum hook approach is the distance from the wall to the nearest possible position of the hook. *The smaller the distance, the better will be the floor area utilization.*
 11. **End Approach** – This term describes the minimum horizontal distance parallel to the runway, between the outermost extremities of the crane and the centerline of the hook.
 12. **Bridge, Trolley and Lift Speeds** - The rate at which the bridge or trolley travels or at which the hoist lifts is usually specified in feet per minute or FPM. The crane operating speeds are selected to allow safe operation while using the pendant. Dual operating speeds, normally a fast and slow speed with a ratio of 4:1, are commonly used, but for optimum control a variable speed control system is preferred.
 13. **Electrical Requirements** - Ideally 480 volt, 3 phase, 60 hertz for US requirements. The runway power is usually by a conductor bar, and a hoisting trolley by festoon cable. The control circuit voltage at pendant pushbuttons shall not exceed 150 volts for AC and 300 volts for DC.
-

PART - 2

CLASSIFICATION OF CRANES

In this section we will discuss:

- ❖ Crane Duty Groups
- ❖ Comparison between different Standards

CRANE DUTY GROUPS

Crane duty groups are a set of service classifications defined based on the frequency of use and percentage of the lifts at or near rated capacity. Two cranes with the same rated capacity and span may differ in their “average load intensity” and/or “expected loading cycles”; hence they will likely differ in their design.

Various standards exist to rate the “service class” of a crane and/or hoist. The Crane Manufacturers Association of America (CMAA) classifies the bridge cranes according to average load intensities and number of cycles. On the other hand, the International Organization for Standardization (ISO), the European Federation Standard (FEM) and the Hoist Manufactures Institute (HMI) all classify hoists according to more rigorous requirements, which include the number of starts and the maximum running time per hour. The following is a short description:

CMAA SERVICE CLASSIFICATION

There are six different classifications of cranes by CMAA based on the duty cycle of crane.

1. **Class A (Stand-by or Infrequent Service)** - This crane is the lightest crane as far as the duty cycle is concerned. This service class covers cranes where precise handlings of equipment at slow speed with long idle periods between lifts are required. Capacity loads may be handled for initial installation of equipment and for infrequent maintenance. Examples of the use of Class A cranes include a transformer station, power houses, turbine halls, motor rooms, public utilities, etc.
2. **Class B (Light Service)** - This service class covers cranes where service requirements are light and speed is slow. Loads may vary from no load to

- occasional full rated loads with 2 to 5 lifts per hour, averaging 10 feet (3 meters) per lift. Examples of class B cranes include service buildings, light assembly operations, repair and maintenance shops, light ware housing, etc.
3. **Class C (Moderate Service)** - Class C cranes are those cranes whose service requirements are deemed moderate. These cranes handle loads averaging 50 percent of the rated capacity, with 5 to 10 lifts per hour averaging 15 feet (4.6 meters), with a maximum of 50 percent of the lifts at rated capacity. Examples of class C cranes are the cranes usually used in paper mill machine rooms, machine shops, etc.
 4. **Class D (Heavy Service)** - In class D crane service, loads approaching 50 percent of the rated capacity is handled constantly during the work period. High speeds are desirable for this type of service with 10 to 20 lifts per hour averaging 15 feet, with not more than 65 percent of the lifts at rated capacity. Typical examples of cranes with heavy service are steel warehouses, foundries, fabricating shops, heavy machine shops container yards, lumber mills, etc. Cranes may be with standard duty bucket or magnet operations where heavy duty production is required.
 5. **Class E (Severe Service)** - Cranes with class E service are capable of handling loads approaching the rated capacity throughout their lives, with 20 or more lifts per hour at or near the rated capacity. Application of cranes with class E include magnet, bucket, or magnet/bucket combination cranes on fertilizer plants, cement plants, scrap yards, lumber mills, container handling, etc.
 6. **Class F (Continuous Severe Service)** - Cranes with class F service are capable of handling loads approaching rated capacity continuously under severe service conditions throughout their lives. Typical examples of such cranes include custom designed specialty cranes essential for performing the critical work tasks affecting the total production facilities. This type of crane must provide the highest reliability with special attention to ease of maintenance features.

In many cases, the classification can easily be determined; however, the code also provides a table that can be used to determine the classification based on more detailed information such as load classes and load cycles.

The four (4) load classes per the code are:

- **L1** – hoist normally lifts with very light loads and very rarely the rated load.
- **L2** – hoist normally lifts loads at 1/3 the rated load and rarely the rated load.
- **L3** – hoist normally lifts loads 1/3 to 2/3 the rated load and lifts the rated load fairly frequently.
- **L4** – hoist regularly lifts close to the rated load.

The four (4) load cycles per the code are:

- **N1** – 20,000 to 100,000 cycles - irregular use followed by long idle periods.
- **N2** – 100,000 to 500,000 cycles - regular use in intermittent operations.
- **N3** – 500,000 to 2,000,000 cycles - regular use in continuous operations.
- **N4** – over 2,000,000 cycles - regular use in severe continuous operations.

Based on the load classes and load cycles, the chart below (an excerpt from CMAA) helps determine a Class of Crane:

Load Classes	Load Cycles			
	N1	N2	N3	N4
L1	A	B	C	D
L2	B	C	D	E
L3	C	D	E	F
L4	D	E	F	F

Note - The Canadian standard B167 closely resembles the Crane Manufacturer’s Association of America (CMAA) standards.

HMI/ASME HOIST DUTY RATINGS

The following table provides an idea of the relative significance of the duty cycle ratings for the various electric hoists. Note that the duty cycle determination for a particular application involves obtaining a significant amount of additional information and skillfully applying it to the intended use.

HMI Class	Operating Based on 65% of Capacity				Details
	Uniform Usage		Infrequent Usage		
	Max On Time (min/hr)	Max Starts/hr	Max on Time From Cold Start	Max Starts	
H1	7.5 minutes (12.5%)	75	15	100	Powerhouse and Utilities, infrequent handling, Hoists used primarily to install and service heavy equipment, loads frequently approach capacity and hoist idle for long periods between uses.
H2	7.5 (12.5%)	75	15	100	Light machine shop fabricating, service and maintenance; loads and utilization randomly distributed; rated loads infrequently handled. Total running time not over 12.5% of the work period.
H3	15 (25%)	150	30	200	General machine shop fabricating, assembly, storage, and warehousing; loads and utilization randomly distributed. Total running time not over 25% of work period.
H4	30 (50%)	300	30	300	High volume handling of heavy loads, frequently near rated load in steel

HMI Class	Operating Based on 65% of Capacity				Details
	Uniform Usage		Infrequent Usage		
	Max On Time (min/hr)	Max Starts/hr	Max on Time From Cold Start	Max Starts	
					warehousing, machine and fabricating shops, mills, and foundries, with total running time not over 50% of the work period. Manual or automatic cycling operations of lighter loads with rated loads infrequently handled such as in heat treating or plating operations, with total running time frequently 50% of the work period
H5	60 (100%)	600	Not Applicable [Note (1)]	Not Applicable [Note (1)]	Bulk handling of material in combination with buckets, magnets, or other heavy attachments. Equipment often cab operated. Duty cycles approaching continuous operation are frequently necessary. User must specify exact details of operation, including weight of attachments.

NOTE (1): Not applicable since there are no infrequent work periods in Class H5 service.

FEM SERVICE CLASSIFICATION

To determine your crane duty group (according to FEM, Fédération Européene de la Manutention) you need to know the following factors:

1. Load spectrum (Indicates the frequency of maximum and smaller loadings during examined time periods).
2. Class of utilization (This is determined according to the number of hoisting cycles during the lifetime of the crane)

Combining these factors is how a duty group is selected.

Example of different load spectrums:

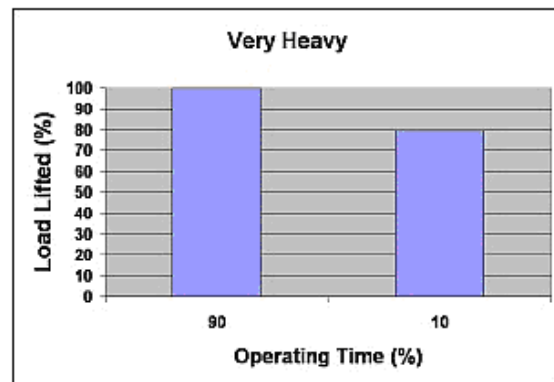
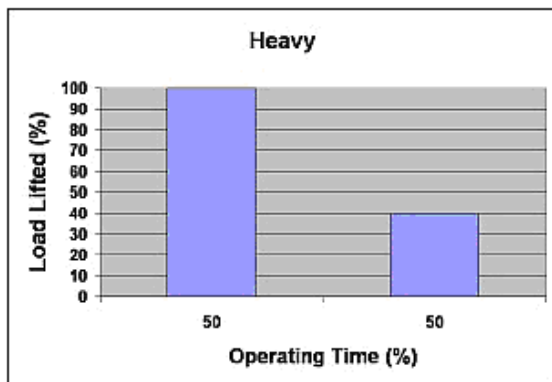
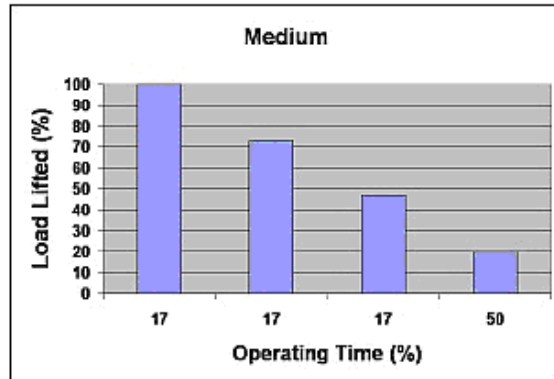
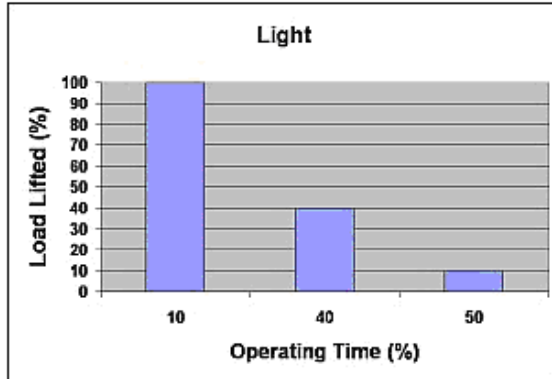

Calculate the Average Daily Operating Time

$$t = (2 \times H \times N \times T) / (V \times 60)$$

Where:

- t = average daily operating time, hours/day
- H = average hoisting height, feet
- N = number of work cycles per hour, cycle/hour
- T = daily working time, hours
- V = hoisting speed, m/min or feet/min

Determine the Operating Group of the Hoist

Load Spectrum	Average Daily Operating Time (hours / day)					
	<= 0.5	<= 1	<= 2	<=4	<= 8	<= 16
Light			M3 1Bm	M4 1Am	M5 2m	M6 3m
Medium		M3 1Bm	M4 1Am	M5 2m	M6 3m	M7 4m
Heavy	M3 1Bm	M4 1Am	M5 2m	M6 3m	M7 4m	
Very Heavy	M4 1Am	M5 2m	M6 3m	M7 4m		

COMPARISON OF VARIOUS STANDARDS (* Machinery Class)

CMAA	A	B	C	D	E	F
FEM	1	2	3	4	5	6
FEM*	1Bm	1Am	2m	3m	4m	5m
ISO*	M3	M4	M5	M6	M7	M8
HMI**	H2	H3	H4	H4+ to H5		

*Based on 63% mean effective load

**Based on 65% mean effective load

Crane Speeds

Selection of speeds is directly dependent on the crane's usage and application.

An overhead bridge crane with too much speed would increase the power rating

of motors as well as the crane's owning and operating cost. Moreover, it can also be dangerous. Not enough speed affects the productivity. Keeping in mind that a standard overhead bridge crane (class "C") is between 2 and 20-ton rated capacity, has about 20-foot height of lift, and spans under 64 feet, the standard speeds are tabulated below although one or two upgrade speeds for each motion is possible.

Capacity	Motion	Standard Speeds (in fpm)
2	Hoist	30
	Trolley	50
	Bridge	60
5	Hoist	15
	Trolley	50
	Bridge	60
7	Hoist	10
	Trolley	50
	Bridge	60
10	Hoist	10
	Trolley	45
	Bridge	60
15 - 20	Hoist	5
	Trolley	45
	Bridge	60

From the table you can see that as the capacity of the crane goes up, the bridge speed, trolley speed and hoisting speed go down.

Many speeds are offered for customized class D, E & F cranes. Bridge speeds for long runways or high-cycle cranes can easily see 300 fpm. Trolley speeds on long-span cranes can top 120 fpm. Hoisting speeds on a high-cycle or a long-lift can advance to 50 or 60 fpm.

Summarizing:

Class and duty cycles of a crane are critical. High duty cycles require special hoists, motors, bearings and controls which are very expensive; whereas low duty cycles permit the use of less expensive components. As an example, suppose a 5-ton low duty cycle crane would cost you \$35,000.00, the same crane with the same load capacity and span but with heavy duty cycle components can cost as much as \$150,000.00. So it's very important to know your requirements and must identify and pass on the following information to the supplier:

1. Average lifts, trolley and bridge movements made in an hour.
 2. Average length of each movement.
 3. Estimation of the load lifted each time.
 4. Total operating hours per day.
-

PART - 3

HOISTS

In this section we will discuss the following:

- ❖ Hoists Lifting Media – Chains or Ropes
- ❖ Types of Hoists
- ❖ Hoist Selection Factors
- ❖ Components of Hoisting Equipment
- ❖ Safety Features
- ❖ Hoist Standards

HOISTS

A hoist is a device used for lifting or lowering a load by means of a drum or lift-wheel around which a rope or chain wraps. Cranes and hoists are somewhat interchangeable terminology since the actual lifting mechanism of a crane is commonly referred to as a hoist. Hoists may be integral to a crane or mounted in an affixed position, permanently or temporarily. When a hoist is mounted to a trolley on a fixed monorail, two directions of load motion are available: forward or reverse, and up or down. When the hoist is mounted on a crane, three directions of load motion are available: right or left, forward or reverse, and up or down. The figure below shows a rope hoist for a single girder crane application.

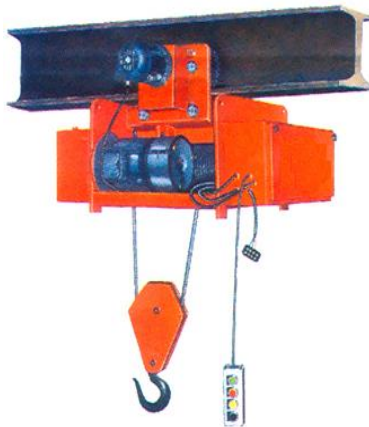

Crane Hoist Supported on Single Girder

A basic hoist can be defined by two characteristics; the lifting medium it uses and its source of power.

Hoist Lifting Media

There are two basic hoist lifting media: wire rope hoist and chain hoist. Chain hoists lift by pulling the chain through sprockets and depositing the chain into a chain container.

- They require less maintenance
- They are less expensive
- They are more common for applications below 7.5 tons

Wire rope hoists lift by wrapping cable around a grooved drum.

- They offer very fast lifting speeds
- They can be rated H-5 (severe duty)
- They dominate the market at 10 tons and above

Which hoist is better: Chain hoist or Wire Rope hoist

Chain Hoist

Chain hoists are used for lower capacity, lighter duty applications and for projects in which cost is a primary deciding factor. The main reasons for choosing a chain hoist are as follows:

1. Ability to change height of lift by changing the chain (versatile)
2. Compact design (no drum, which saves space)
3. Portable and can tolerate greater levels of abuse
4. Provides true vertical lift at no extra cost
5. Capacity up to 15 tons (13.6 tonnes)

Chain hoists do, however, have certain inherent inconveniences such as

1. Limited lifting speed
2. Noisier operation
3. May be problematic at a lift height of over 20 ft (6 meters)

4. Space taken by the chain or chain container

Wire Rope

The wire rope is a piece of equipment that is used mainly for production tasks. The main reasons for choosing a wire rope hoist are as follows:

1. Provides faster speeds
2. Quieter than a chain hoist
3. Recommended for considerable long lifting height
4. Very smooth lifting operation
5. Heavy Safe Working Load up to 25 tons (22.7 tonnes)

Both wire rope and chain hoists available in the market today are rugged and durable products. A good load chain can last up to 30 times longer than a standard wire rope, and it greatly reduces the down time and operational costs. Duty ratings stated in various standards (HMI/DIN / FEM) are a better indicator of the durability of the hoist type (chain or wire rope). Therefore, when purchasing a crane, focus more on lifting speeds, headroom and features, and less on the type of hoist.

Types of Hoists

1. **Manual Hoists** - Manual hoists are designed for occasional, non-production lifting where fast lifting is not required. Manual hoists feature two different chains; one to lift and lower the load (control or hand chain) and one to support the load (load chain). Manual hoists are operated by manually raising or lowering the control chain using a "hand over hand" motion to lift or lower the load. The pulling action of the hand chain turns a series of gears and sprockets located inside the hoist, which results in the raising or lowering of the load chain and hence the load itself. Manual hoists (chain falls) are available in ½-ton to 25-ton capacities and are ideal for use in rigging, maintenance, construction, shipbuilding, and automotive applications.
2. **Electric Hoists** - Electric hoists utilize an electric motor to turn the hoist's internal gearing which in turn raises or lowers the load connected to the load chain. The clockwise or counterclockwise rotation of the drum is controlled by the operator's

use of a pendant control featuring up and down buttons as well as an optional emergency safety stop. The electric motors found in hoists more often than not utilize either 220v/ 440v or 230v / 460v voltage and typically require a hard wire type connection. However, some of the lighter duty shop hoists operate on 110v and can actually be plugged right into a household style electrical wall outlet. Electric hoists are fairly economical, but are limited in their use by what is known as their duty cycle. Every electric motor requires a certain amount of rest after a period of use. Disregarding the duty cycle ratings of an electric motor will result in premature motor failure and costly repairs. Electric hoists are not designed for 100% duty cycle operation and are not recommended for continuous production use. They are available in 1/8-ton all the way up to 100-ton capacities.

3. **Pneumatic (Air) Hoists** - Pneumatic hoists are typically used in industrial production environments. These units feature either a rotary vane or piston driven air motor powered by compressed air. The greatest benefit of air hoists is that they have a 100% duty cycle rating, meaning unlike their electric counterparts, they never need to rest. Pneumatic hoists are however, only as good as the quality, pressure, and flow rate of the air that feeds them. One disadvantage of air hoists is that they consume a moderate to large amount of compressed air, which in turn calls for an air compressor capable of producing enough air flow to meet the cubic feet per minute (CFM) requirements of the hoist. Hoists operated below the rated CFM will not perform to their rated performance. Additionally, clean, dry, and lubricated air is critical to extending the operating life of an air hoist.

HOIST SELECTION FACTORS

To select the proper hoist, consider:

- 1) **Capacity** - The weight of the load to be lifted including below-the-hook lifting, load supporting, and positioning devices. Hoists range in capacity from 275 lbs. (1/8 ton) to over 220,000 lbs. (100 tons). When choosing the right hoist for the job, always use maximums that can be expected to occur.

- 2) **Lift** - The vertical distance the load can be moved. Lift should be measured from the pick-up point of the object, to the bottom of the load hook when the hoist is in its fully retracted position. When calculating the amount of lift required, remember to take into consideration the actual height of the object being lifted. For example, if the distance from the lower hook of the hoist (in its retracted position) to the floor is ten feet, but the object and its pick up point sit two feet off the ground, only 8 feet of lift or "chain" is required.

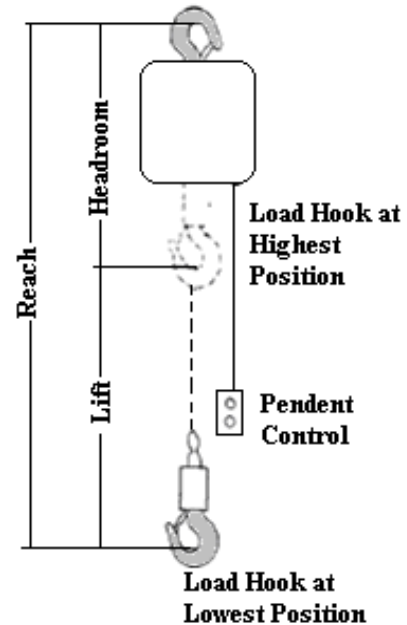

- 3) **Drop** - This simply refers to the amount of hand chain, electric cable, or air hose length offered as part of the control package. If for instance you are buying a hoist for a lowering application and plan on operating the hoist from a platform (think of unloading items off the deck of a ship unto a dock) adjacent to the hoist, you would most likely require a less than standard amount of drop. If however, you wanted to operate that same hoist from the area where the load pick up is to be made, you would need a considerably greater amount of drop.
- 4) **Lifting Speeds** – The lifting and lowering speeds at which a hoist operates are measured in feet per minute (FPM). Typically, there is an inverse relationship between the lifting speed and the capacity of the hoist. That is, higher capacity hoists operate at slower speeds and lower capacity hoists operate at higher speeds. Sometimes however, the same model hoist will be offered in the same capacity, but with several different options for the speed. Furthermore, some hoists are offered in dual speed models which provide greater flexibility in their use.
- 5) **Controls** - Whether it's a manual, pneumatic, or electric hoist; the length and type of controls must be carefully selected prior to ordering a hoist. As mentioned previously, a manual chain hoist (chain fall) is controlled by a pull chain. Electric and pneumatic hoists feature pendant controls that

dictate the lifting direction of the hoist. Electric models feature push button controls while pneumatic pendants utilize levers and valves to control the load.

6) **Hook, Lug, or Trolley Mounted** – Hoists can be mounted in three basic fashions. Hook mounted hoists utilize a snap style upper hook to connect to a beam clamp, trolley, or pre-drilled hole in an I-beam. Hook mounting results in a less than rigid connection allowing the body of the hoist to sway with the load. In contrast, a lug mounted connection results in more rigidity because the upper suspension of the hoist is connected to a bracket or trolley using a solid metal rod known as a lug. This cylindrical rod, acts as a stabilizer bolt of sorts, preventing the hoist from swaying with the weight of the load.

7) **Hoist Duty Cycle considerations:**

- Number of lifts per hour
- Total number of lifts per shift
- Maximum number of starts and stops per hour
- Number of shifts per day
- Average distance load is raised and lowered
- Average weight to be lifted
- Maximum weight to be lifted
- Frequency of lifts with maximum weight

(Refer to HMI/ASME Hoist duty ratings table in section-2 to get an idea of the relative significance of the duty cycle ratings for the various hoists.)

Other Key Selection Factors

Other questions include whether the load is in one piece. Will it fall apart when lifted? Does it have built-in lifting points? Is special equipment needed to lift it? Care should obviously be taken not to exceed the safe working load of the equipment involved; particularly in multi-point lifting operations. Note the following desired characteristics:

1. The number of starts and stops per hour directly affects all electro-mechanical devices such as motors, contactors, brakes, and solenoids due to high inrush amperage at startup being approximately 3 times the normal running amps. Operator training and proper equipment selection can minimize this frequent source of equipment damage. Two speed motors and inverters can solve many of the spotting problems that result from the improper "staccato"; use of the push button by the operator.
2. The type of use will help determine the equipment class of service:
 - Maintenance and production applications must use Class H4 at a minimum (200 to 300 starts/stops an hour) and a safety factor of 5:1 for ultimate stress.
 - For molten metal service, use a safety factor of 10:1 for ultimate stress for hook, cable and bottom block.
3. When making a hoist selection with regard to the maximum capacity load to be lifted, consider that ball bearing life for the equipment normally varies inversely according to the cube of the load. For example, a 2-ton hoist operated at a mean effective load of 1 ton will have a ball bearing life eight times that of the same hoist used steadily at its rated load. Select your hoist wisely to account for the repairs and downtime for critical use hoists.
4. The hoist may use various types of lifting attachments ranging from a simple hook, lifting beam or automatic grab. Lifting attachments should be equipped with a safety latch to prevent the disengagement of the lifting wire, chain or rope to which the load is attached.
5. When ordering a hoist with a trolley, preferably request lug mounting by stationary retaining bracket. This type of mounting provides a more compact, rigid and sturdy package. However, if you want the hoist to disconnect easily from the trolley, choose hook mounting.
6. Power supply and control cords, cord reels, hoses, electrification systems, and flexible festooning systems provide means for supplying power to hoists. Such systems must be properly sized and meet all prevailing codes or regulations.

Components of Hoisting Equipment

The main components of hoisting equipment are:

- Motor with integrated brake
- Controls
- Hoist drum
- Wire rope
- Load block
- Load hook

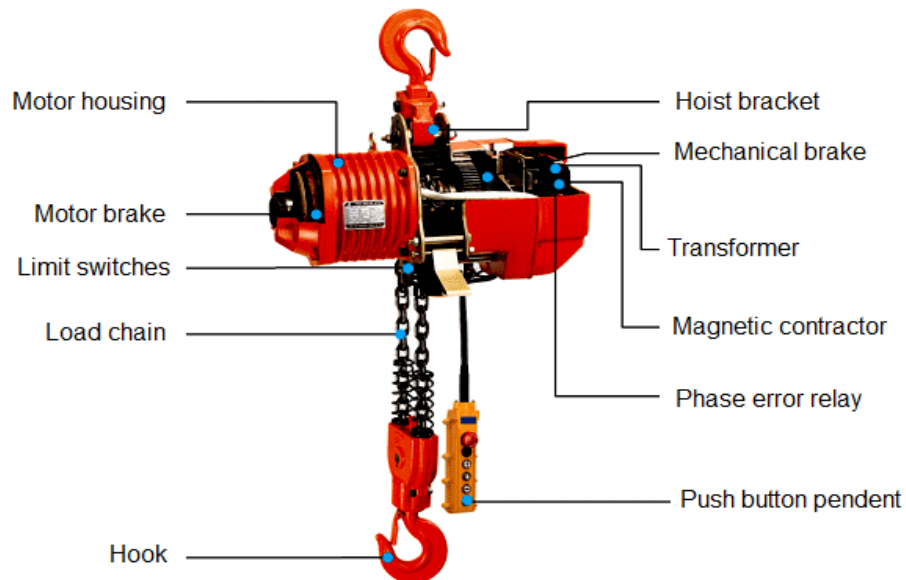

Drum: The drum is the cylindrical member around which the ropes are wound for lifting or lowering the load.

Load Block: Load block or hook block is used for raising and lowering the hook. It is an assembly of hook, swivel, bearings, sheaves, pins and frame suspended from the hoisting ropes. The supporting member for the sheaves is called the sheave pin and the supporting member for the hook is called the trunnion.

Sheaves: A sheave is a grooved wheel or pulley used with a rope or chain to change the direction and point of application of a pulling force. The rule of thumb is that the diameter of a sheave must be about 20 times the diameter of the rope. The depth of an open sheave must be 1.5 times the diameter of the

rope and where the rope is contained in the sheave, the minimum depth of the sheave must equal the diameter of the rope.

Trolley: A trolley is a device that rests and rolls along the beam. There are three types of standard trolleys:

- Push Trolley - Recommended for light capacities and lifts below 20 feet. An economical method for moving loads.
- Hand-Geared Trolley - Offers most precise control for load spotting. Most favorable for higher capacities and short monorails where the control is desired. Also recommended where lifts are above 20 feet.
- Motor-Driven Trolley - It's a powered device equipped with control pendant to lift, drop and maneuver the load to the desired direction. Virtually it is a necessity where long spans and loads greater than 2 tons are to be lifted.

Hook Assembly: Hooks are mostly drop forged from 80 grade alloy steel and heat-treated for strength and toughness. Two common types of hooks are rigid and swivel hooks. The rigid hook as it sounds does not swivel or rotate whereas a swivel hook allows the hoist to spin clockwise or counterclockwise during operation. Hooks may be fitted with a safety latch, especially where there is the possibility of the slings being displaced.

Design of almost all the components of the hoisting mechanism is influenced by the maximum load capacity and the lift. In some cases it is necessary to arrange for a secondary hoisting machinery, called the auxiliary hoist, to lift a much lighter load. Note the following:

- Multiple hoists with independent payloads are permitted on a single support structure if the combined rated load of the hoists does not exceed the rated load of the support structure of a crane girder.
- Multiple hoists can be attached to a single payload if the combined rated load of the hoists does not exceed the rated load of the support structure of a crane girder.

- The maximum permitted load is determined by the hoist with the lowest rating. Example: 1 ton and 600 lb hoists are connected to the same payload. The maximum hook capacity for the payload is 600 lbs.

SAFETY FEATURES

1. **Safe Working Load and Marking of Hoist** - The applicable safe working load of the hoist must be clearly and legibly marked on its body. The hoist shall not be used to carry any load greater than the applicable safe working load except during tests by a competent examiner. Hoists shall be provided with an overload switch that stops the hoisting operation when the lifted load exceeds the rated working load limit of the hoist.
2. **Hoist Drum/Pulley** - A hoist drum/pulley shall be of a sufficient diameter and construction for the rope used. The rope that terminates at the winding drum of a hoist shall:
 - a. be properly secured to the drum; and
 - b. Have at least two turns of the rope remaining on the drum at each anchorage of the hoist drum when the hook is in its extreme low position.
3. **Controlling Devices** - Every lever, handle, switch, or other device used for controlling the operation of any part of a hoist shall:
 - a. Be provided with a suitable spring or other locking arrangement to prevent accidental movement or displacement of such controlling device that is liable to cause danger; and
 - b. Have on or adjacent to it clear markings to indicate its purpose and the mode of operation.
4. **Hoist Brakes** - The hoist shall have at least two independent means of braking; a holding brake and a controlling brake.
 - a. Holding brakes on hoists shall be applied automatically when power is removed. This means that if you have a power failure, the brake will continue to hold the load until power is restored. Most codes require at least two holding brakes for cranes utilizing hot metal service.

- b. The function of secondary controlling brake is to prevent speeding when lowering the load and to prevent the load from falling out of control dangerously. For the secondary brake, some hoist manufacturers use a mechanical brake. Others (about 80 percent) use a regenerative brake. A mechanical load brake will hold the load if the primary brake fails. However, this brake generates a lot of heat and usually isn't recommended for applications involving more than 30 tons of loads or for high-frequency applications. Also, it is expensive and seldom used anymore. The critical fact about a regenerative brake is that it does not hold the load in the event of a primary brake failure, but rather will lower the load at its normal operating speed.
5. **Hoist Limit Switches** - The hoist have limits they can travel. The limit switches prevent over-winding and over-lowering of the hook block. Upper limit switch in a hoist is designed to prevent the hook assembly from colliding with the drum. Similarly, a lower limit switch prevents operating the hoist too far in a downward direction. The lower limit will keep two full turns of rope on the drum when the hook is in its lowest working position and may prevent the hook from making contact with the ground.

Caution: Limit switches are safety devices and not operation devices. They are not meant to be used as a method for stopping the hoist at predetermined points.

Working Load Limits (WLLs) of Attachments

Below are the rule of thumb methods of calculating the WLL's of flexible steel wire rope, chain and fiber rope. Please note that these methods only give approximate answers.

1. Flexible steel wire rope (FSWR)

Formula: $WLL \text{ (kgs)} = D^2 \text{ (mm)} \times 8$

For example: Rope diameter (D) = 12mm

$WLL \text{ (kgs)} = D^2 \text{ (mm)} \times 8$

$= D \text{ (mm)} \times D \text{ (mm)} \times 8$

$$= 12 \times 12 \times 8 = 1152 \text{ kgs}$$

$$\text{WLL (t)} = 1.15 \text{ tonnes}$$

The above equation can be reversed to calculate the diameter (D) in millimeters of FSWR needed to lift a given load. To do this; divide the load (L) in kilograms by 8 and find the square root of the result.

2. Chain

The WLL of chain is determined by the grade (G).

$$\text{Formula: WLL (kgs)} = D^2 \text{ (mm)} \times G \times 0.3$$

For example:

Chain diameter – 10mm, Chain grade (T) i.e. grade 80

$$\text{WLL} = D^2 \text{ (mm)} \times G \times 0.3$$

$$= D \text{ (mm)} \times D \text{ (mm)} \times G \times 0.3$$

$$= 10 \times 10 \times 80 \times 0.3$$

$$= 2400 \text{ kgs}$$

$$\text{WLL (t)} = 2.4 \text{ tonnes.}$$

Grade 80 super alloy load chain is commonly used and heat-treated for long life. The safety factor is more than 6-1. Load chain is zinc plated for resistance against corrosion.

3. Fiber Rope

$$\text{Formula: WLL (kgs)} = D^2 \text{ (mm)}$$

For example: Diameter = 25mm

$$\text{WLL (kgs)} = D^2 \text{ (mm)}$$

$$\text{WLL (kgs)} = D \text{ (mm)} \times D \text{ (mm)}$$

$$= 25 \times 25$$

$$= 625 \text{ kgs}$$

$$\text{WLL (t)} = 0.625 \text{ tonnes.}$$

Caution:

- a. Flat webbing and round synthetic slings are labelled with the WLL. Do not lift if the label is missing. Return to the manufacturer for testing and relabeling. Synthetic slings are color coded.
- b. Do not use a chain to lift if it does not have a manufacturer's tag that gives details of the WLL. Return it to the manufacturer for WLL assessment and re-tagging.

HOIST STANDARDS

There are many standards produced by many different standards-writing bodies. Generally, for hoist installations in the US, the standards published by the American Society of Mechanical Engineers apply. Three are safety standards and six are performance standards. All carry the American National Standards Institute (ANSI) designator for a consensus American National Standard (ANS):

1. ASME-HST-1 Performance Standard for Electric Chain Hoists
2. ASME-HST-2 Performance Standard for Hand Chain Manually Operated Chain Hoists
3. ASME-HST-3 Performance Standard for Manually Lever Operated Chain Hoists
4. ASME-HST-4 Performance Standard for Overhead Electric Wire Rope Hoists
5. ASME-HST-5 Performance Standard for Air Chain Hoists
6. ASME-HST-6 Performance Standard for Air Wire Rope Hoists
7. ASME-B30.7 Safety Standard for Base Mounted Drum Hoists
8. ASME-B30.16 Safety Standard for Overhead Hoists (Under hung)
9. ASME-B30.21 Safety Standard Manually Lever-Operated Hoists
10. OSHA (Parts 1910 and 1926) adopts or invokes the American Society of Mechanical Engineers (ASME) HST Performance and B30 Safety Standards for hoists and related equipment.

PART - 4 STRUCTURAL DESIGN CONSIDERATIONS

In this section we will discuss the following:

- ❖ Crane Runway
- ❖ Crane Loads on the Runway Girder
- ❖ Design of Crane Runway Girder
- ❖ Typical Profile of Crane Girder
- ❖ Crane Runway Girder and the Building Structure
- ❖ Crane Rails, Stops and Bumpers

CRANE RUNWAY

Crane runway may be defined as the track and support system on which the crane operates. It comprises of crane rails, rail attachments, supports for electrification, crane stops, crane column attachment, tie back and the girder itself. All of these items should be incorporated into the design and detailing of the crane runway girder system.

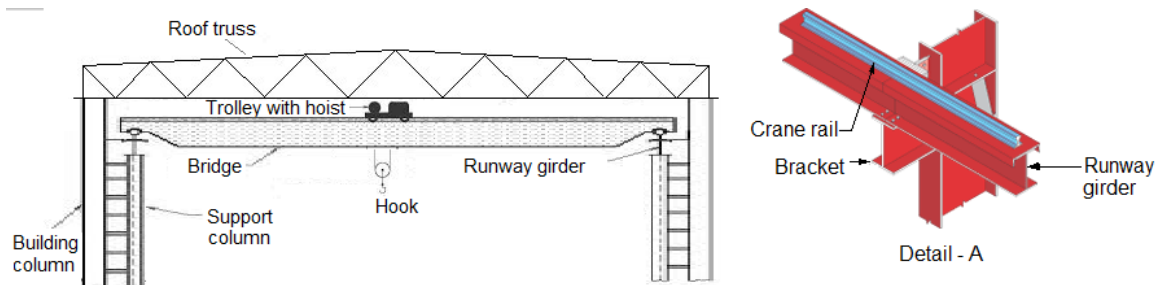

Crane runways should be thought as a stationary part of the building structure and are designed accordingly.

Quality Assurance

All structural steel members of the handling system shall be designed in accordance with the specifications of the American Institute of Steel Construction (AISC) current edition and any welded construction shall be in accordance with the standard of the American Welding Society (AWS).

CRANE LOADS

Successful design of the crane runway and associated supporting structure relies on the interactions between the moving crane and the stationary runway. Three principal types of loads (forces) induce a complex pattern of stresses in the upper part of the girder and the structural framing of the building. We will discuss the various loads (forces) below:

1. **Vertical Loads** - Vertical crane loads are termed as wheel loads. The maximum wheel load (MWL) is the sum of:

- The weight of the trolley (carriage) and lifted load, plus,
- The weight of the crane bridge, plus,
- The self-weight of the crane girder and rails.

MWL occurs when the crane is lifting its rated capacity load, and the trolley is positioned at the extreme end of the bridge directly adjacent to the girder. In addition to the shear and bending stresses in the girder cross-section, the wheel loads result in localized stresses under the wheel.

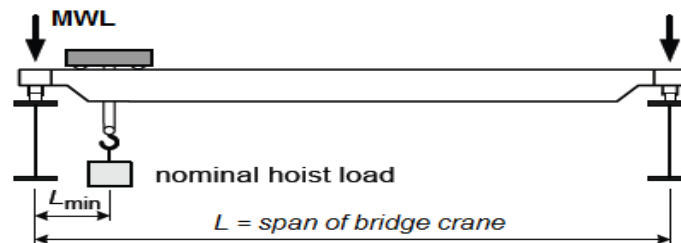

2. **Lateral Loads (side thrust)** - Lateral crane loads are oriented perpendicular to the crane runway and are applied at the top of the rails. Lateral loads are caused by:

- Acceleration and deceleration of the trolley and loads
- Non-vertical lifting
- Unbalanced drive mechanisms

- Oblique or skewed travel of the bridge

The magnitude of the lateral load due to trolley movement and non-vertical lifting is limited by the coefficient of friction between the end truck wheels and rails.

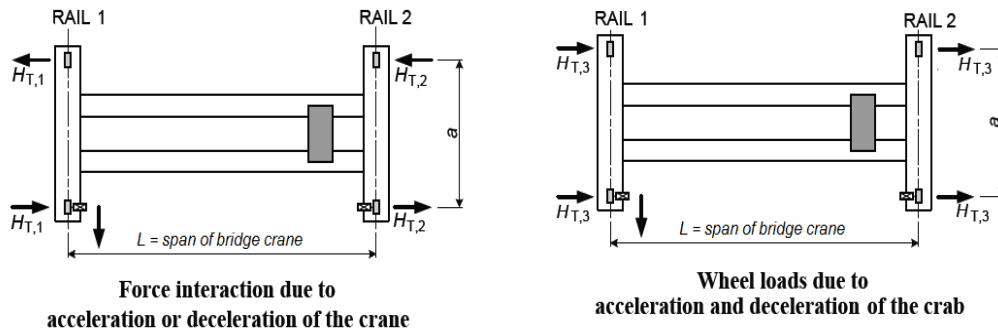

H_{T1} and H_{T2} are the horizontal lateral or transverse forces at the wheels, which act as a couple as a result of the force moment. H_{T1} and H_{T2} are influenced by the wheel spacing (a) and the dynamic behavior of the crane during acceleration and deceleration. Provided that the payload is free to swing, the horizontal load H_{T3} represents the horizontal transverse wheel force related to the movement of the crab. The wheel forces can also be in an opposite direction.

If the drive mechanism is not balanced, acceleration and deceleration of the bridge crane results in skewing of the bridge relative to the runways. The skewing imparts lateral loads onto the crane girder.

Oblique travel refers to the fact that bridge cranes cannot travel in a perfectly straight line down the center of runway. It may be thought of as similar to the motion of an automobile with one inflated tire.

The AISC specification and most model building codes set the magnitude of lateral loads at 20% of the sum of the weights of the trolley and the lifted load.

3. **Longitudinal Forces (traction load and bumper impact loads)** - Longitudinal crane forces are due to either acceleration or deceleration of the bridge crane or the crane impacting the bumper.

- **Tractive forces** - are limited by the coefficient of friction of the steel wheel on the rails.
- **Impact load** - is the longitudinal force exerted on the crane runway by a moving crane striking the end stop. The impact force is a function of the length of the stroke of the bumper and the velocity of the crane upon impact with the crane stop.

The longitudinal forces are normally provided by the crane manufacturer. If this information is not available, the AISE Guide (1996) provides equations that can be used for determining the bumper forces. If the number of driven wheels is unknown, take the tractive force as 10% of the total wheel loads.

The figure below indicates the longitudinal impact forces and the relation of these forces to the deformation of the buffers.

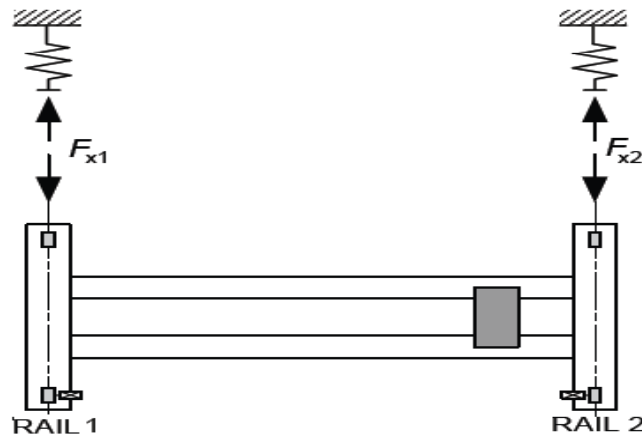

Force configuration during buffer impact

DESIGN OF THE CRANE RUNWAY GIRDER

The crane girders are subjected to 1) the vertical loads, 2) the horizontal lateral loads, and 3) the horizontal longitudinal forces that induce various types of stresses on the building structure. The predominant loading is vertical and the next principal loading is the lateral force. The figure below shows the cross section of a steel building system with the associated crane loads.

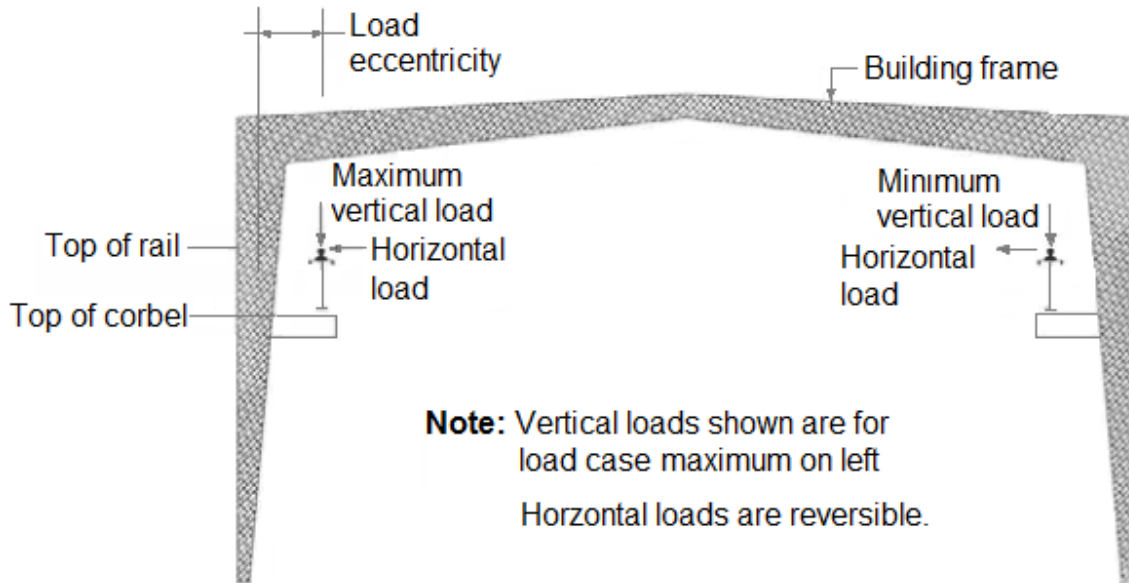

The crane runway girder is usually designed as a simple span beam and the structural analysis of the beam involves determining the location of the maximum design moments and shear due to the crane traveling along the length of the crane beam. When performing the analysis, both the horizontal forces (lateral and longitudinal) are assumed NOT to act together with the vertical loads simultaneously. Only one of them is considered to be acting with the vertical load at a time.

The procedure below outlines the steps and calculations involved in selecting a runway beam for a 4-wheel top running crane having 2 wheels per end truck.

1) Maximum Wheel Load (MWL)

MWL means the load on any wheel with the trolley and rated capacity load positioned on the bridge to give the maximum loading condition on that wheel. *MWL will occur when the trolley and rated capacity load are positioned at the extreme end of the bridge and on cranes without a cab or platform.* MWL is calculated as follows:

$$MWL = K * P/2 + H/2 + C/4$$

Where

- P = Rated capacity loads in pounds (1 metric ton = 1000 kg = 2205 lbs; and 1 imperial ton = 2000 lbs)

- H = Weight of hoist and trolley in pounds
- C = Weight of crane in pounds
- K = Impact allowance factor (Impact allowance of the rated capacity load shall be taken as ½ % of the load per foot per minute of hoisting speed, but not less than 15% or more than 50%, except for bucket and magnet cranes for which the impact allowance shall be taken as 50% of the rated capacity load.) Therefore: $K = 1 + (.005) * (S)$, where S is the hoist hook speed in feet per minute. If a fixed bridge cab or platform is used, ½ of the weight of the cab or platform and mounted equipment shall be added to MWL.

2) Equivalent Center Load (ECL)

ECL is the load that, when applied in a concentrated loading condition at the center of the runway span length between specified supports, causes a bending stress in the beam equivalent to the bending stress that occurs in the beam when a 2-wheel top running end truck of a specified wheel base operates on it.

ECL is calculated by multiplying MWL by multiplication factor K1 or $ECL = K1 * MWL$

(Refer to item 4 below for estimating K1.)

3) Maximum Support Load (MSL)

Loading at the runway span supports will vary as the two equal moving loads change position during operation on the runway. The maximum loading condition must be known for the design of the support, and it is called MSL caused by the moving crane loads.

MSL is calculated by multiplying MWL by multiplication factor K2 or $MSL = K2 * MWL$

(Refer to item 4 below for estimating K2.)

Note: The above calculated MSL is based on the loading caused by the crane only. The total load on the support applied in the support design must also include the runway beam weight, lateral and longitudinal loads caused by the

crane trolley and bridge movement, and the weight of any attachments and equipment mounted on the runway.

4) Determining K1 and K2

The following information for calculating ECL and MSL is based on the standard AISC equations for a simple beam having two equal concentrated moving loads.

- Step 1 – Calculate Ratio A/L

The figure below represents a runway beam span length between supports on which two equal moving loads are operating and separated by a distance equal to the crane and truck wheel base. Each moving load is equal to MWL and can be calculated by procedures outlined above.

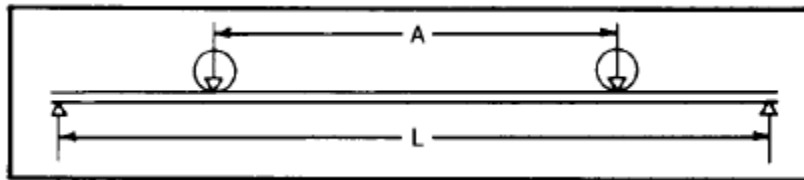

Calculate the ratio A/L , where A = truck wheel base, and L = runway span length between supports. Values of A and L must be in the same units (feet or inches).

- Step 2 - Select Multiplication Factors (K1 & K2)

From the following table, select the multiplication factors $K1$ and $K2$ based on the calculated A/L ratio. When the calculated value of A/L falls between the A/L values shown in the table, use the next lower tabulated A/L value.

A/L	> 0.05	0.05	0.1	0.15	0.20	0.25	0.30
K1	2.000	1.902	1.805	1.712	1.620	1.532	1.445
K2	2.000	1.950	1.900	1.850	1.800	1.750	1.700

A/L	0.35	0.40	0.45	0.50	0.55	0.60	0.65
K1	1.362	1.280	1.202	1.125	1.052	1.000	1.000
K2	1.650	1.600	1.550	1.500	1.450	1.400	1.350
A/L	0.70	0.75	0.80	0.85	0.90	0.95	1.00 or greater
K1	1.000	1.000	1.000	1.000	1.000	1.000	1.000
K2	1.300	1.250	1.200	1.150	1.100	1.050	1.000

5) Select Runway Beam Size

Maximum center loads (MCL) for various beams and composite beams for American Standard Shapes (I-Beam) are available in steel design handbooks. Any beam or composite beam having MCL greater than ECL for the span length under consideration may be used as the runway beam size.

Example

A crane having a rated capacity of 7.5 tons has a top running trolley hoist weighing 2,975 lbs. The crane operates on a runway span of 25 feet with a hook speed of 27 feet per minute and weighs 5,935 lbs. The end truck has a wheel base of 7 ft - 8 in. Calculate the MWL, ECL and the beam size.

Calculate MWL

$$MWL = K * P/2 + H/2 + C/4$$

$$K = 1 + (0.005) (S)$$

$$K = 1 + (0.005) (27)$$

$$K = 1.135$$

$$P = 7.5 \times 2000 = 15000 \text{ lbs}$$

$$H = 2975 \text{ lbs}$$

$$C = 5935 \text{ lbs}$$

$$MWL = 1.15 * 15000 / 2 + 2975/2 + 5935/4$$

$$MWL = 12971 \text{ lbs}$$

Calculating A/L ratio

$$A = 7.67 \text{ ft}$$

$$L = 20 \text{ ft}$$

$$A/L = 7.67/20 = 0.383$$

Table does not have and A/L value of 0.385, therefore, interpolating the value;

$$A/L = 0.305$$

$$K1 = 1.305$$

$$ECL = K1 \times MWL$$

$$ECL = 1.305 * 12971 \text{ lbs}$$

$$ECL = 16927 \text{ lbs}$$

Referring to MCL tabulation for American Standard Shapes (I-beam), a beam must be selected that has a MCL greater than 16,927 lbs when the span length is 20'. S20 x 66 has a MCL of 17,330 lbs and therefore can be used.

TYPICAL PROFILE OF CRANE GIRDERS

The usual structural members for runway beams are standard I-beams or beams reinforced with plate, angles or channels. It is of utmost importance to judiciously select the height and width of the beam. As a rough guideline, the usual range of girder depth-to-span ratios is between 8 and 14. The deflection limitation may dictate a larger depth, especially where spans are long. An auxiliary girder or other suitable means shall be provided to support overhanging loads to prevent undue torsional and lateral deflections. The figures below show a typical wide flange beam crane girder:

- For small spans and light-to-medium crane loads, it is normally possible to use rolled-beam sections, figure (a).

- Single web plate girders are suitable for the majority of heavier cranes. Their insufficient resistance to lateral forces is normally solved by introducing web stiffeners as shown in figure (b).

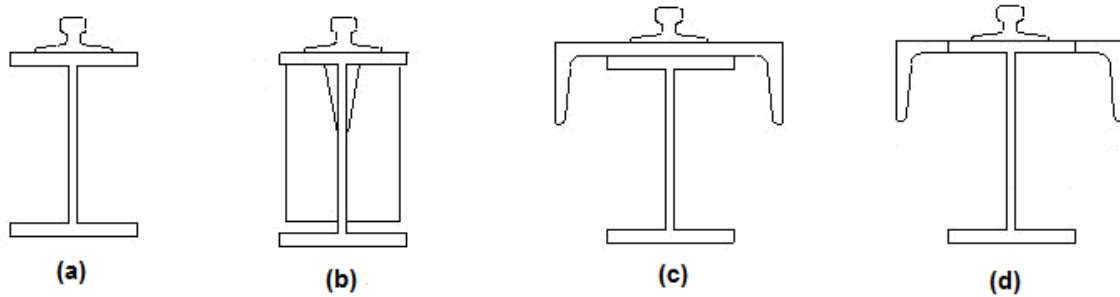

Rolled Girder

Stiffened Plate Girder

Built up Girder

- In some cases reinforcement or capping may be necessary to give resistance to lateral forces. This capping, usually channels, figure (c) or angles, figure (d), increases the lateral stiffness as well as the moments of inertia and the section moduli in compression. Capping should be used only in special instances where a wide flange beam does not quite meet the requirements of the width of flange or compression, or a welded girder should be less economical.

The design and selection of crane runway girders has some special aspects listed below:

Fatigue Considerations

Crane runway girders are subjected to repetitive load effects due to a number of crane passages per hour (or per day). It is a common practice for the crane girder to be designed for a service life that is consistent with the crane classification. The correlation between CMAA crane designations and AISC loading conditions can be seen in the table below:

Crane Loading Conditions

CMMA Crane Classification	AISC Loading Condition
A, B	1
C, D	2
E	3
F	4

The critical details in fatigue design are adding web stiffeners, flange stiffeners and/or the flange-to-web connections where severe concentrations of stresses exist. The stiffening is carried out by welding the vertical plate(s) to the web. The method of attaching the stiffeners to the web and the flanges must be detailed carefully to prevent fatigue failure. The following recommendations are made:

- Welds attaching the stiffeners to the girder web should be terminated at a distance from the flanges to reduce the stress concentration.
- Welds connecting the web to the top flange should be full penetration butt welds, although fillet welds are sometimes used for light, primarily static cranes.

High strength steel is seldom used in crane runway girders because fatigue considerations limit the permissible stresses quite severely and thus reduce the economical advantages. (The fatigue strengths of mild and high strength steel for welded structures are the same.) Additionally, deflection and lateral-torsional buckling considerations also prevent the designer from gaining the advantage of using high strength steel.

Rigidity Requirements

In addition to the strength requirements, it is also important to check the vertical and horizontal deflections of the girder as these may determine the girder design, in many instances, over the strength formula. Normally, the following

maximum values for the deflection of the crane girder must not be exceeded to avoid undesirable dynamic effects and to secure the function of the crane:

- a. Vertical deflection is defined as the maximum permissible deflection ratio allowed for a lifting device. For a bridge crane this value is usually:
 - Span/600 for Class A, B or C crane
 - Span/800 for Class D crane
 - Span/1000 for Class E and F crane
- b. Horizontal deflection is the maximum deflection ratio allowed for a bridge crane or runway. This value is usually Span/400 for all service classifications.

In the absence of more detailed calculations, it is acceptable to assume that the top flange resists the whole horizontal force. The rigidity requirement for horizontal deflection is essential to prevent oblique traveling of the crane. The vertical deflection is normally limited to a value not greater than 25 mm to prevent excessive vibrations caused by the crane operation and crane travel.

CRANE RUNWAY GIRDER AND THE BUILDING STRUCTURE

The support method of the crane runway girder depends on the magnitude of the reactions being transmitted, in relation to the strength of the structural framing of the building. Some typical arrangements for supporting top-running cranes ranging from the lightest to the heaviest are shown in the figures below.

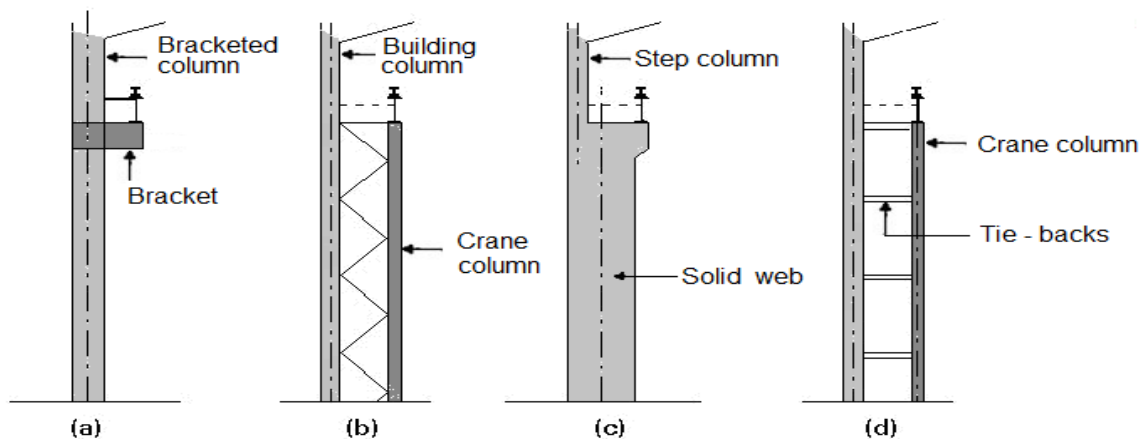

CRANE COLUMNS

Fig (a) - Crane runway girders supported on brackets secured to columns

Where a traveling crane of relatively low capacity (up to say 10 tons) is required, brackets can be fixed to the columns to support the crane rails. Use of a tie member or rigid column bases may be necessary to reduce the eaves' deflection. Above this capacity, it is better to provide a separate leg or to increase the depth of the column below the crane runway girder to give adequate support.

Fig (b) & (d) - A separate crane column

When an overhead traveling crane is introduced into a building, special care must be taken to ensure that the building is adequately braced in both directions. This arrangement is attractive to heavy cranes as it permits the effect of the crane to be considered isolated. However there lies a danger, since the displacement of the building column could induce overstress in the connection between the two columns.

Fig (c) - Analyze the columns as one

Where heavy cranes are involved, the crane runway girders may be subjected to severe fatigue conditions. This arrangement is a correct and more realistic approach to provide stability.

Careful consideration should be given to the transfer of the horizontal forces from the top flange of the girder to the column. The best way to reduce stresses from the crane runway girder to the column or bracket below is by means of welded brackets (refer to the figure below). The top flange acts as a horizontal beam delivering its reaction to the column.

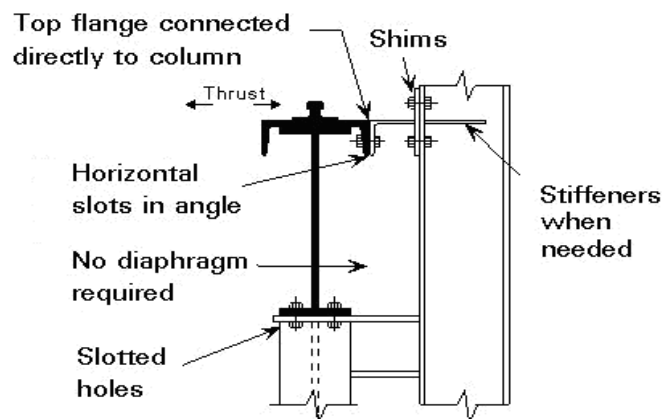

CRANE RAILS

Crane rails are furnished to ASTM A759 and/ or manufacturer's specifications and tolerances.

It is important to know what type of crane is going to be applied when designing the crane rail and runway girder. Loading characteristics should be adopted in accordance with the crane manufacturer's manual. In practice, it is sometimes impossible to prepare the design of the crane and the crane runway girder at the same time because the crane is ordered much later than the building structure. The result may be a poor design leading to problems such as excessive wear of the crane rail and crane wheel flanges, or fatigue cracking in the upper web of the girder.

The crane rail must meet the requirements for protecting the top flange from wear and for distributing the wheel loads evenly over the greatest possible length of contact. The crane rail must therefore have:

1. An adequate wear resistance,
2. A high flexural rigidity, and
3. Rail Splices. There are two types of splices:
 - Splices which join individual lengths
 - Expansion splices

Longer rail lengths can be obtained by welding rather than by bolting. Welded splices are normally superior to bolted splices because the welded joint avoids a gap and gives a step-free running surface. Special care is required in the welding operation if there are high carbon and manganese contents in the steel.

Expansion joints in rails must be provided on long runways when rails are fixed to the girders. They should coincide with joints in the main girder.

Rail Attachments

The rail-to-girder attachments must perform the following functions:

- Transfer the lateral loads from the top of the rail to the top of the girder,
- Allow the rail to float longitudinally relative to the top flange of the girder,

- Hold the rail in place laterally, and
- Allow for lateral adjustment or alignment of the rail.

The relative longitudinal movement of the crane rail to the top flange of the crane girder is caused by the longitudinal expansion and contraction of the rail in response to changes in temperature and shortening of the girder compression flange due to the applied vertical load of the crane.

The crane rail must be centered on the crane runway beams. There are four commonly accepted methods of attaching light rails supporting relatively small and light duty cranes.

Hook Bolts are sometimes called J-Bolts because of the obvious “J” shape. These work well for smaller crane girders that do not have adequate space on the top flange for rail clips or clamps. They can be installed around the crane rail girder directly, or around a cap channel atop the girder. The figure below shows the rail fastening using hook bolts.

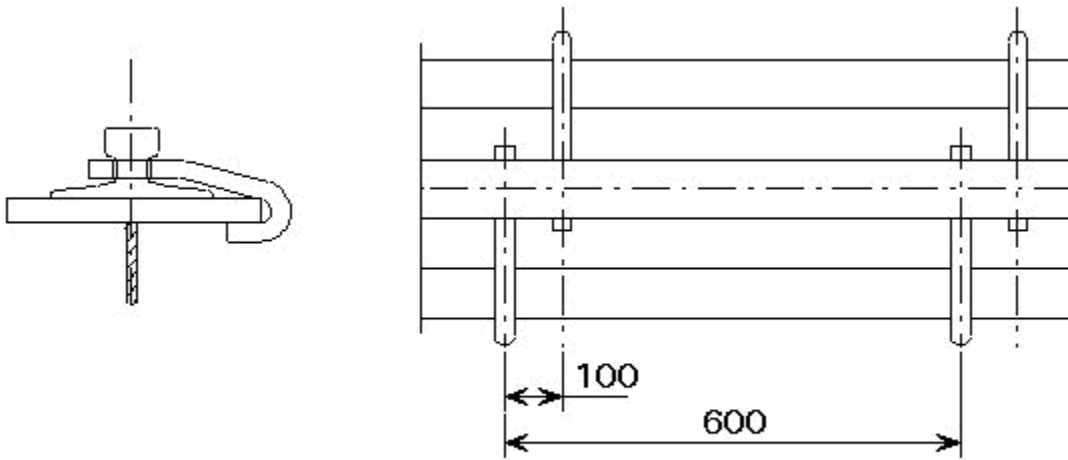

RAIL FASTENINGS USING HOOK BOLTS

Here are the key characteristics of hook bolts:

- They are very commonly used to attach lighter rails (usually up to 85 LB) to cap channels or directly onto a crane rail beam. These are not recommended for runways over 50 ft' long, for heavier rail sections, or for heavy duty applications.

- They are threaded to allow up to one half inch lateral adjustment in either direction, and are completely supplied with hex nuts and lock washers.
- They are typically installed in pairs, four inches apart every two feet.
- They attach through holes drilled in the rail web, 1/8" inch larger than the diameter of the hook bolt.
- They can stretch over time and allow the rail to become loose. Hook Bolts also restrict normal longitudinal movement due to thermal expansion and contraction as well as movement from the crane skid and wheel spin.
- They make rail lateral adjustments very difficult because each bolt must be loosened, moved and retightened.
- The use of hook bolts eliminates the need to drill the top flange of the girder. However, these savings are offset by the need to drill the rails.

Rail clips are one-piece castings or forgings that are usually bolted to the top of the girder flange. Many clips are held in place with a single bolt. The single bolt type of clip is susceptible to twisting due to longitudinal movement of the rail. This twisting of the clip causes a camming action that tends to push the rail out of alignment.

Rail clamps are two-part forgings or pressed steel assemblies that are bolted to the top flange of the girder. The AISE Guide recommends that rail clips allow for the longitudinal float of the rail and that they restrict the lateral movement to inward or outward. When crane rails are installed with resilient pads between the rail and the girder, the amount of lateral movement should be restricted to 1/32 in. to reduce the tendency of the pad to work out from under the rail.

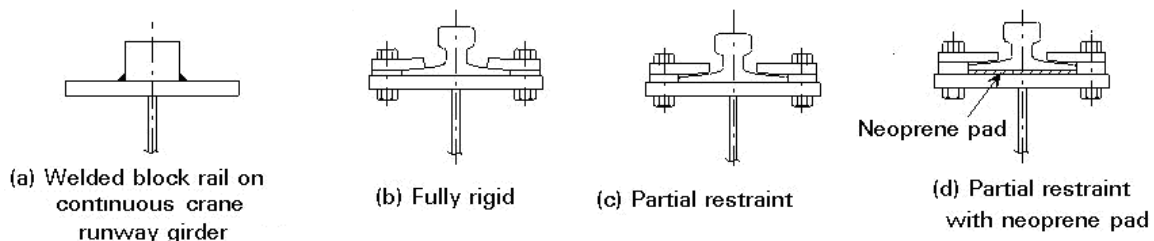

RAIL FASTENINGS

STOPS AND BUMPERS

Wheel stops are devices whose objective is to limit the travel of trolley or bridge. Bumpers act as energy absorbing devices to reduce impact when a moving bridge reaches the end of its permitted travel.

For bridge speeds in excess of 250 fpm, the crane should be provided with bumpers capable of stopping the crane when traveling in either direction at 50% of the rated full load speed, and at a rate of deceleration not to exceed 16 fps. Such bumpers shall have sufficient energy absorbing capacity to stop the crane while traveling at a speed of at least 50% of the full load rated speed.

Bumpers may be spring, hydraulic, rubber, polyurethane, or other shock absorbing materials. The prime function of the bumper is to protect the crane from damage due to hitting stops at the end of the runway or contacting other cranes on the same runway.

Summarizing

The crane runways and supporting structures shall be designed to withstand the loads and forces imposed by the crane. Steel crane runways and supporting structures should conform to the design parameters as specified in the applicable AISC Manual of Steel Construction. The key design factors include:

- Runway columns shall be securely anchored to foundations.
- The structure shall be free from detrimental vibration under normal operating conditions.
- Rails shall be level, straight joined, and spaced to the crane span within tolerances as specified in CMAA Specification No. 70, or within tolerances that are compatible with special conditions specified by the crane manufacturer or a qualified person.
- Simplified calculations are adequate for light load cranes, but more rigorous analysis are required for heavy load cranes. The depth of structural investigations can be decided from the class of the crane.
- Although the minimum weight design may provide an economical solution to many design problems, this is not the case in the design of crane

runway girders where the overall costs must include the maintenance costs.

- Welded fabrication should be given a more rigorous inspection than the rest of the building structure.
 - No further welding attachments should be allowed during the lifetime of an intensively used crane girder.
-

PART - 5 CRANE ELECTRIFICATION & POWER SUPPLY

In this section we will discuss the following:

- ❖ Methods of Crane Electrification
 - ❖ Bridge and Runway Electrification
 - ❖ Festoon Systems
 - ❖ Motors and Controllers
 - ❖ Enclosures – NEMA Standards
 - ❖ Electrical Grounding
 - ❖ Control Systems
-

There are two circuits in most hoist electrification systems: power and control.

1. **Power Circuit** - The power circuit provides the energy to lift loads and run other motors that perform work. Since bridges, trolleys and hoists move during operation, there must be powered by appropriate means.
2. **Control Circuit** - The control circuit is another secondary low voltage electrical circuit that supplies power to the control functions. The crane or hoist is normally operated by some type of push-button arrangement held in the operator's hand. The benefit of reducing shock hazard by reducing the voltage and current are obvious.

Methods of Crane Electrification

Two common methods of crane electrification are: 1) insulated power bar, and 2) festooning.

1. **Insulated power bars** - This method uses insulated bars with a sliding shoe collector system, which removes most of the exposed conductor safety hazards and provides an option of very high amperage compared to other power systems. Although this is an improvement over other methods, the shoes wear out quickly.
2. **Festoon** - The flat cable on a trolley traveling on a C rail provides direct contact, which is extremely wear resistant. This system provides

advantage of superior reliability; however, it is not recommended for curves.

At the present time insulated power bar is the preferred choice for crane runway electrification while festooning is the choice for bridge cross conductors and floating pushbuttons. Routing festoon systems becomes somewhat of a problem when more than one separately moving systems must operate on the same runway or bridge. When you consider that two or more bridges often operate on one runway system, use of the insulated bar for runways makes sense.

CRANE BRIDGE & RUNWAY ELECTRIFICATION

The figure below shows a basic insulated power bar arrangement for the crane runway:

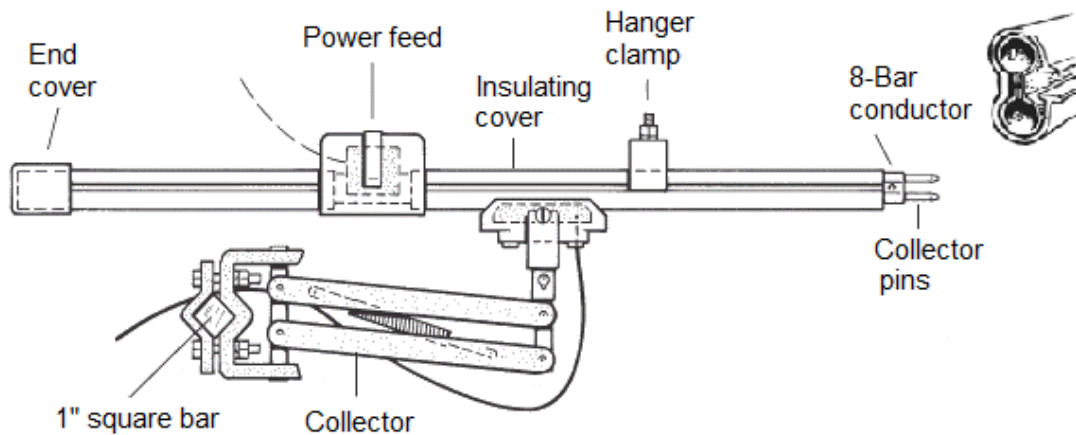

Power supply to the runway electrification consist of a series of insulated bars made out of galvanized steel, copper, stainless steel, or aluminum, which transmit electricity through sliding collector assemblies that power the motors, trolleys, hoists, etc.

1. Conductor Bars – Track electrification shall be accomplished by a UL approved conductor continuous bar.
 - Conductor bars shall be one piece, copper conductors complete with thermoplastic insulating covers and end covers. The insulated bars are also called 8-bar systems because the bar inside the insulation, when viewed from the end, looks like the figure 8. Conductors shall be accurately aligned to ensure positive electrical contact between the collectors and the conductors. Separate conductors shall be provided

for each phase, and more than one conductor in a single enclosure shall not be permitted.

- Maximum voltage drop from the building power takeoff point for the track electrification system to the hoist motor shall not exceed 4%, and the equivalent conductance shall not be less than No. 4 American Wire Gage (AWG) copper wire. The size of bridge conductors shall be proportioned to limit the total voltage drop in the conductors to a maximum of 3 percent of the supply voltage when the current on the individual motors is on full load.
 - Short-circuit current rating of conductors shall be not less than 10,000 amperes.
 - Continuous-current, thermal rating of conductors shall not exceed 140°F (60°C) based on an ambient temperature of 86°F (30°C).
2. Power feed – This is an attachment for incoming power and is a fully insulated simple clamp type which is easily installed anywhere on the system for incoming power to the conductor rails. The power supply to the runway conductors shall be controlled by a switch or circuit breaker located on a fixed structure, accessible from the floor, and arranged to be locked in the open position.
- A fused, manual disconnect switch with a lockable handle mounted through the panel door shall be provided and wired into the incoming power circuit.
 - All power for crane shall be supplied through one main visible blade fuse switch located on the crane bridge in an easily accessible position.
3. Collectors – A current collector assembly consists of a spring loaded sliding contact type shoe of hard copper alloy or sintered copper graphite. A shoe shall be mounted in an insulating case of phenolic or urea compound of suitable temperature and insulation quality. Exposed parts of the current collectors shall be grounded and of corrosion-resistant material.

- A current collector assembly shall be designed to operate through gaps, splices and switches and shall be self-centering. It shall include expansion sections for every 150 feet (45,720 mm) for systems using galvanized steel conductors and every 100 feet (30,480 mm) for systems using copper conductors.
4. Hangers and supports – Bars are attached to brackets that are typically either web mounted (for top running cranes), flange mounted (for monorails or under-hung cranes), or laterally mounted.

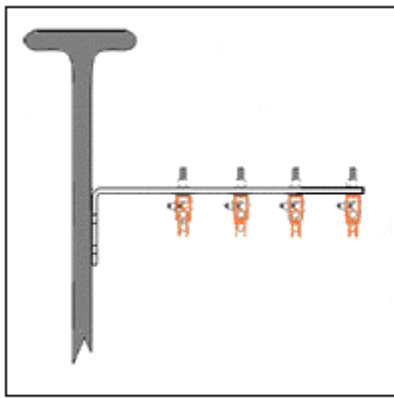

Web mount

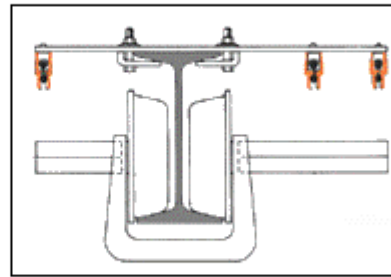

Flange mount

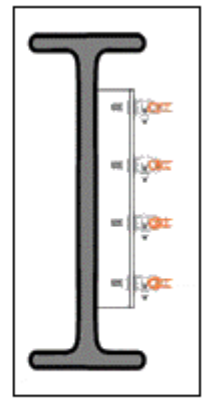

Lateral mount

5. End covers – They are used to cover the exposed ends of the conductors to avoid accidental contact.
6. Insulating covers – Insulating covers are rigid PVC, self-extinguishing, with a heat distortion point of 160°F at 260 psi.
7. Connector pins – They are used to join the conductor bar sections together.

The system shall be complete with unit length conductors, insulating conductor covers, insulators, splices and splice covers, end caps, support brackets and fasteners, current collectors, expansion, isolation and power-interrupting sections, disconnect switches, and conduits and wiring to power takeoff point.

Typical Installation Guidelines

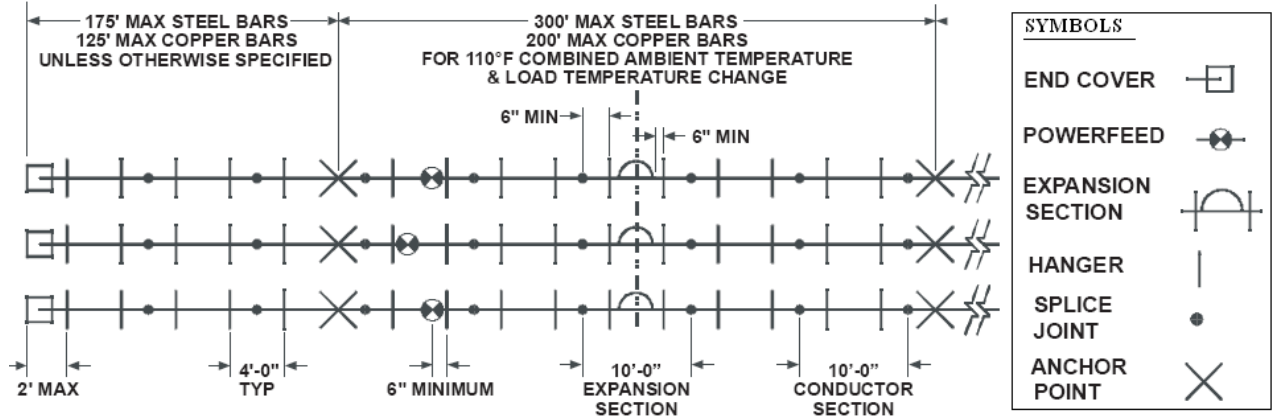

The expansion section shall be considered at a 350-foot length for steel conductors and 250-foot length for copper conductors. Expansion sections are required to compensate for thermal expansion.

Standard hanger spacing should be every 4 feet for straight runs and every 3 feet for curves.

In order to properly select a bar system, it is necessary to determine the following:

- Type of System (monorail, runway, bridge)
- Length of Run
- Number of Cranes and Current Requirements
- Number of Conductors (calculate an extra for ground)
- Location of Power Feed
- System Voltage
- Temperature and Duty Cycle
- Environment

Festoon Systems

Festoon Systems are categorized as either a C-Track or Tagline (wire) design. C-Track Festoons are used for providing power to a runway, hoisting trolley, bridge crane auxiliaries, or lower voltage control to a separate pendant station circuit. The Festoon Cable is typically flat, but round versions are also found.

The benefits of a flat cable over round is that the flat cable will stack up without twisting, and the trolleys can accommodate multiple layers of cable. Tagline Festoons are generally used for providing power and control to a hoist system or a smaller crane.

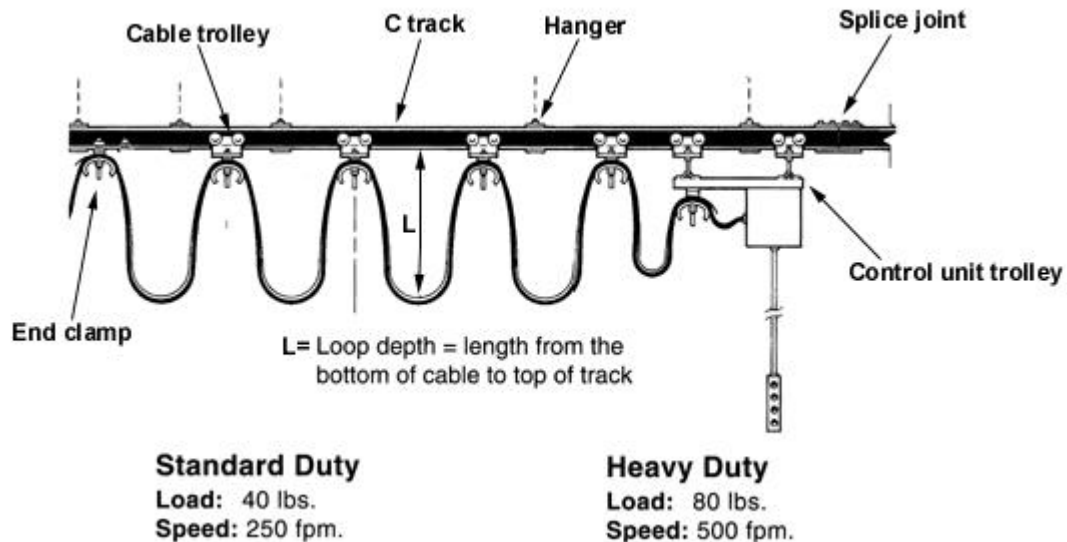

C-Track Festoon System

The typical specifications for a festooned bridge conductor system are as follows:

A festooned bridge conductor system shall consist of extra-flexible stranded copper conductors and cross-linked 90°C polyethylene insulation rated 1000V with high temperature outer jacket. Conductor sizes shall be as recommended by the hoist and trolley manufacturer.

Cables to the trolley shall be suspended from a rail type cable support system called “messenger track” that shall be mounted above one of the main bridge platforms to provide safe access to the cables and catenary system. The festooned wires may be used to transmit current from the bridge to the trolley or from the bridge to a pendant control unit.

MOTORS AND CONTROLS

Depending on the application, the electric overhead traveling cranes require motors at three areas:

- a. Bridge and end truck motors

- b. Trolley motors
- c. Hoist motors

Motor Specifications

Duty cycle assigned to the motor is one of the important factors in the selection and operation of motors for crane service, as it depends on how often and how long a motor operates. The operating conditions such as duty cycle, startup, temperature and operating environment are vital considerations in the motor efficiency and reliability. It is absolutely essential to match the motors to their specified operating conditions for minimizing stresses on the motors and to get predetermined performance and life.

Both AC and DC drives are used for the different operations on a crane. The preferred drives in consideration of economy and utility are indicated below:

Operation	Type of drive
Hoisting and lowering	AC slip ring motor, controlled DC shunt motor and DC compound motor.
Crane travel	AC slip ring motor.
Trolley travel	AC slip ring motor.
Slew and swing action	AC slip ring motor or DC shunt motor.
Boom hoist	AC slip ring motor.

Slip-ring motors are useful:

1. Where very precise speed control is required, for e.g. inching, slow and fast handling of load during hoisting and lowering, alignment of crane over a furnace opening, etc.
2. In case of non-uniform loading conditions and operation is to be carried out in number of sequences.

3. Where the cranes are required to perform large number of starting and reversals during operation.
4. Where the cranes are required to have a starting torque of more than 2.5 times the rated torque in general.

DC motors are used for load hoisting and lowering where smooth, precise and, at the same time, fast speed control is required as in the case of cranes used in steel plants, power houses and concrete dams.

Squirrel Cage Motors may also be used for various crane service applications:

1. Where the driven equipment is to be accelerated rapidly with a fixed sequence of operation and uniform load conditions, e.g. mechanical workshop crane.
2. If the load conditions are almost identical for both directions of rotation, e.g. long travel or cross travel of gantry crane.
3. If the cranes which are running at single speed without speed control.
4. If site conditions are dusty, corrosive, where these motors with totally enclosed fan cooled construction would be robust and would provide services with least maintenance.
5. Where the cost factor is to be considered, as cost of cage motor is less than that of slip-ring motor.

Selection Criteria

Most vital and primary technical considerations for the selection of a motor for crane service is the ability to operate under varying load conditions, speed control, sequential switching and suitability to quickly reverse due to the requirement of handling materials of varied weights (i.e. loads).

1. **Speed control** - This is an essential feature in crane drives. It is required for allowing soft starting and stopping of the travel motions to enable the correct positioning of load. For the lifting drive, the speed control in a wide speed range, from zero to nominal values, is required. Because of the precision when raising and lowering the load, the possibility of working at a very low speed and holding a load in the standstill is required, without using the mechanical brakes. DC is still the best choice

but AC systems should be able to achieve performance standards comparable to that of DC SCR systems, provided that the proper drive and motor are selected. If AC motor is to be used, there are two major concerns that will drive your decision making process.

- a. Heat - The primary concern is generation of very high heat output which must be dissipated. For example, a 40 HP, 2:1 gearless AC with 50% counterweighting would produce 22 KW of regenerated power in the form of heat.
 - b. Cost - The alternative is to use a regenerative AC drive, which avoids the heat problem, but will cost 1.5 to 2.5 times as much as a non-regenerative drive (standard flux vector drive).
2. **Torque and Power** - The other important consideration is the high torque required by the load during starting and accelerating periods. The torque and power that have to be delivered by the drive may be obtained from the torque versus speed characteristic from the load (called mechanical characteristics). Typical AC drive operating characteristics are:
- a. Below full load RPM → Output produced in constant torque mode
 - b. Above full load RPM → Output produced in constant HP mode

This means that, above full load RPM, the AC motor output torque decreases. So the Full Load RPM of a motor must be within 5% of the RPM required to run the hoist at contact speed. Use Full Load RPM data (not synchronous RPM data) to select an AC motor.

3. **Time Delay** - Recognize that AC drives have an inherent delay in starting, which may affect overall performance time. Unlike DC applications, where the motor field is energized at all times, in AC applications, the motor is energized (via power contactor) on demand. Sufficient time must be allowed for magnetic flux to build within the motor before the brake can be lifted. Delay time may vary from 200 milliseconds to over one second, depending on motor characteristics. Therefore, all other factors being the same, the AC motor and drive must tolerate a delay on start which does not exist with DC motors and drives.

4. **Motor Type** - Drives shall be rated to carry the full load current of the hoist motors continuously for 10 minutes. Drives shall be rated to carry the full load current of the long and cross travel motors continuously for 5 minutes. Motors shall be totally enclosed, non-ventilated type, certified for 30-minute time-rated operation at full identification plate power output in an ambient temperature of 104°F (40°C), maximum temperature rise 167°F (75°C), and insulation not less than a Class B system. Motors for hazardous environment, where indicated, shall be explosion proof.

Final Selection - As a common practice, where the variable loads are to be operated, a motor rating is selected based on the highest anticipated load. However, a more efficient and cost effective approach is to select the motor having a rating slightly lower than the peak anticipated load and let it be operated at overload for a short time duration, rather than selecting the motor of high rating that would operate at full capacity for only a short period providing optimum efficiency only for that much duration. The only concern for motors operating at higher than their ratings is the thermal capacity of the motor, which determines the speed of degradation of the winding insulation.

ENCLOSURES

The enclosures house all of the electrical components on the crane and are rated by the National Electrical Manufacturers Association (NEMA) as to the level of protection they provide from the conditions in the surrounding environment. Typically, the most common practice is to specify NEMA 1 level of protection for all electrical equipment and NEMA 12 for all controls panels.

NEMA Standards Summarized

NEMA Type	NEMA Definition*	Application for NEMA Enclosures*
1	Enclosures are intended for indoor use primarily to provide a degree of protection against contact with the enclosed equipment in areas where	Enclosures are suitable for general application indoors where atmospheric conditions are normal. These enclosures provide limited protection

NEMA Type	NEMA Definition*	Application for NEMA Enclosures*
	unusual service conditions do not exist.	against falling dust but are not dust tight.
2	Enclosures are intended for indoor use primarily to provide a degree of protection against limited amounts of falling dust and water. NEMA Standard 1-10-1979	Drip tight (indoor) enclosures are similar to Type 1 enclosures with the addition of drip shields, and are suitable for application where condensation may be severe such as that encountered in cooling rooms or laundries.
3	Enclosures are intended for outdoor use primarily to provide a degree of protection against windblown dust, rain, sleet and external ice formation. NEMA Standard 1-10-1979	Suitable for applications outdoors on ship docks, canal locks, construction work and for application in tunnels and subways. Use indoors where dripping water is a problem.
3R	Enclosures are intended for outdoor use primarily to provide limited protection against falling rain, sleet and external ice formation. (May be ventilated). NEMA Standard 1-10-1979	Outdoor use to provide a degree of protection against falling rain and sleet; undamaged by the formation of ice on the enclosure.
4	Enclosures are intended for indoor or outdoor use primarily to provide a degree of protection against windblown dust and rain, splashing water, and hose-directed water. NEMA	Water tight enclosures are suitable for dairies, breweries, etc., where they are subjected to large amounts of water from any angle. (They are not submersible)

NEMA Type	NEMA Definition*	Application for NEMA Enclosures*
	Standard 1-10-1979	
4X	Enclosures are for indoor or outdoor use primarily to provide a degree of protection against corrosion, windblown dust and rain, splashing water and hose directed water. NEMA Standard 1-10-1979	Corrosion resistant enclosures satisfy the requirements of Type 4, and are suitable for food processing plants, dairies, refineries and any other industries where corrosion is prominent.
5	Enclosures are intended for indoor use primarily to provide a degree of protection against settling airborne dust, falling dirt and dripping non-corrosive liquids. NEMA Standard 5-25-1988.	
6	Enclosures are for indoor or outdoor use primarily to provide a degree of protection against the entry of water during occasional and temporary submersion at a limited depth. NEMA Standard 1-10-1979	Submersible enclosures are suitable for application where the equipment may be subject to submersion such as quarries, mines and manholes. The enclosure design will depend upon the specified conditions of pressure and time.
7	Enclosures are for indoor use in locations that are classified as Class I, Groups A, B, C or D, as defined in the National Electric Code. NEMA Standard 1-10-	Hazardous areas indoor classified as shown.

NEMA Type	NEMA Definition*	Application for NEMA Enclosures*
	1979.	
8	Enclosures are for indoor or outdoor use in locations that are classified as Class I, Groups A, B, C, or D, as defined in the National Electric Code. NEMA Standard 1-10-1979	Hazardous areas indoor or outdoor classified as shown.
9	Enclosures are for indoor use in locations classified as Class II, Groups E, F, or G, as defined in the National Electrical Code. NEMA Standard 5-19-1986	Hazardous areas indoor enclosures classified as Class II, Group E, F, or G.
12	Enclosures are intended for indoor use primarily to provide a degree of protection against dust, falling dirt and dripping non-corrosive liquids. NEMA Standard 1-10-1979.	Indoor uses to protect the equipment against flying fibers, lint, dust, and light splashing, seepage, dripping, and external condensation of non-corrosive liquids.
13	Enclosures are intended for indoor use primarily to provide a degree of protection against dust, spraying water, oil, and non-corrosive coolant. NEMA Standard 1-10-1979	Indoor enclosures intended primarily to house pilot devices such as limit switches, push buttons, selector switches, pilot lights, etc., and to protect these devices against lint and dust, seepage, external condensation, and spraying of water, oil, and co

ELECTRICAL GROUNDING

Grounding is a critical part of a safe installation. More and more cranes are equipped with electronics such as remote controls, variable frequency, electronic monitoring devices, etc. These need grounding for their protection.

Per NEC 610; Overhead Crane/Hoist Grounding code, all exposed non-current-carrying metal parts of cranes, hoists and accessories, including pendant controls, shall be bonded either by mechanical connections or bonding jumpers, where applicable, so that the entire crane or hoist is a ground-fault current path as required or permitted by Article 250, (grounding) Parts V and VII.

Moving parts, other than removable accessories, or attachments that have metal-to-metal bearing surfaces, shall be considered to be electrically bonded to each other through bearing surfaces for grounding purposes. The trolley frame and bridge frame shall NOT be considered as electrically grounded through the bridge and trolley wheels and its respective tracks. A separate bonding conductor for grounding the bridge and trolley wheels and its respective tracks shall be provided per 2005 NEC (610.61).

CONTROL SYSTEM

A variety of control systems are possible such as pendant control from floor, fixed cabin control, movable cabin control, control through radio remote control etc.

1. **Pendant control** - Most bridge and gantry cranes are controlled by a pendant push button control suspended from the crane structure. The controls are normally push button. Pendant controls usually have:

- North – South
- East – West
- Up – Down
- Emergency Stop

They may also have a creep speed control allowing for smooth acceleration and deceleration. A Variable Frequency Drive (VFD) is used to vary the frequency of the motors controlling the motions. The buttons

on the pendant operate a VFD unit operated in much the same way as 'Two Speed control'. The control provided by a VFD allows for a high level of customization.

The pendant may be suspended from the trolley hoist, requiring the operator to walk with and beside the load, or on a separate sliding track system allowing the operator to move independently of the load. The bottom of the control station shall be approximately 48 inches (1,220 mm) above the operating floor level. A limit switch shall be provided to prevent power from being applied to the crane travel motor when the crane track beam is interlocked to a fixed track beam.

The pushbutton station shall be grounded to the hoist and crane bridge. A strain-reliever chain or cable shall not be used as a grounding circuit. Pushbuttons shall be designed to transmit a distinct notch or step feeling to the operator for each pressure or release action on hand-controlled speed points.

2. **Cabin controls** - Most modern cranes have joy sticks to control the movement of the hoist, the long travel and cross travel movement and the raising and lowering of the hook. Cabin controls are used for a wide range of applications particularly where it is not possible to have a clear walkway or where the driver must be protected. For example, in the steel industry the driver must be kept away from the intense heat of the molten steel transported by the cranes.
3. **Remote controls** - Remote controls can be either infrared or radio controlled. The radio control performs exactly like the pendant but operates using a radio frequency. The radio control incorporates numerous safety features and allows the operator a greater range of operator motion than a pendant. Radio control shall be from a portable console and shall preferably utilize 'Ethernet' communications for the link. As a backup to radio control all crane functions shall also be controllable from the pushbutton station. Both infrared and radio controlled remote controls have a limited range. Infrared controls must be pointed towards the crane during operation or the crane will stop.

ELECTRICAL STANDARDS

Crane, bridge-trolley, runway and hoist wiring, contact conductors, controls, over-current protection, and grounding shall conform to NFPA 70. All electrical equipment shall be in accordance with NEMA Publication No. ICS 8 and National Electric Code Article 610 (Cranes and Hoists).

The control circuit voltage shall not exceed 600 volts for AC or DC current. Ideally 480 volt, 3 phase, 60 hertz meets US requirements.

The voltage at pendant pushbuttons shall not exceed 150 volts for AC and 300 volts for DC.

PART - 6

DESIGN SPECIFICATIONS

In this section we will discuss the following:

- ❖ Specifications and Codes
- ❖ Structural Requirements
- ❖ Mechanical Requirements
- ❖ Electrical & Control Requirements

General Specification and Codes

1. Top running cranes and their appurtenances shall conform to the requirements of CMAA 70 (latest edition) – Specifications for Top Running Bridge & Gantry Type Multiple Girder Electric Overhead Traveling Cranes.
2. Crane components and appurtenances required for safe operation and maintenance shall be in accordance with OSHA regulations Par. 1910.179 Overhead and Gantry Cranes and ASME B30.2-2001.
3. Crane hoist and trolley shall be in accordance with Hoist Manufacturers Institute HMI 100-74, Specification for Electric Wire Rope Hoist.
4. Crane hooks shall be in accordance with ASME B30.10-Hooks and shall be of the single fishhook design with spring type safety latch.
5. Runway rails and bridge girder shall be fabricated from structural steel conforming to ASTM Designation A-36 and shall have a maximum deflection of 1/600 of the span length under maximum loading conditions. The runway rails and bridge girders shall be provided with travel stops.
6. In general, electric overhead traveling cranes shall conform in design, materials, construction, and performance with the current issue of the following specifications, codes and standards.

CMAA 70 Specification for Top Running Bridge & Gantry Type
Multiple Girder Electric Overhead Traveling Cranes

AGMA American Gear Manufacturer’s Association

ASME HST-4	Performance Standard for Overhead Electric Wire Rope Hoists
ASME Y 14.1	Decimal Inch Drawing Sheet Size and Format
ASME B18.2.2	Square and Hex Nuts
ASME B30.2	Overhead and Gantry Cranes (Top Running Bridge, Single or Multiple Girder, Top Running Trolley Hoist)
ASME B30.10	Hooks
AWS D14.1	American Welding Society – Specification for Welding of Industrial and Mill Cranes
HMI 100-74	Hoist Manufacturer's Institute - Specification for Electric Wire Rope Hoists
NEC 610-14	Determining Amperage Requirements for Cranes and Hoists
NEMA ICS 8	Industrial Control and Systems - Crane and Hoist Controllers
NFPA70	National Electrical Code
OSHA	Occupational Safety & Health Administration
IBC	International Building Code (This will eventually replace UBC)
UBC	Uniform Building Code

The available literature on crane indicates that the procedural design of cranes is highly standardized. Consideration of the available technology and components is mainly based on the accumulated previous experience on various design projects and the time spent on crane selection is mostly for interpretation and implementation of the available design standards. However correct interpretation is important for better performance, higher safety and more reliable designs.

Many international and/or national standards and rules are available to guide the crane designers for that purpose; e.g. BS 357 , AISE Standard No.6, CMAA No.70 and 74, JIS B8801, DIN 44 and "FEM Rules" . All of these standards

offer design methods and empirical approaches and formulae that are based on previous design experiences and widely accepted design procedures.

QUALITY ASSURANCE

All equipment and appurtenances furnished under this solicitation shall be equal to the named products and shall conform to the applicable requirements of the following:

- CMAA No. 74 - Crane Manufacturers Association of America
- ASME HST-4M-1996 - Performance Standard for Overhead Electric Wire Rope Hoists
- NEMA - National Electrical Manufacturers Association
- NEC - National Electrical Code

All structural steel members of the handling system shall be designed in accordance with the specifications of the American Institute of Steel Construction (AISC), current edition and any welded construction shall be in accordance with the standard of the American Welding Society.

(Refer to other international codes in Appendix C.)

COMPONENTS – KEY CHARACTERISTICS

Crane bridge and end truck assembly, trolley rails, and beam runways shall be designed and fabricated in accordance with AISC 317 and CMAA 70, Section 70-2, "Crane Classifications." Salient features of few key components are described below:

Steel

1. Steel for crane bridges, end truck frames, auxiliary girders, trusses, and reinforcing shall be hot-rolled structural steel I-beams, wide flange beams, channels, and angles and plates not less than ASTM A-36 or equivalent.
2. Girders and track beams shall be true, straight and free of twists with standard mill tolerances for crane use. Runway track beams that carry rails shall conform to CMAA 70.

Structural Connections

The main structural connections on overhead traveling cranes shall be high strength bolts, usually either ASTM A-325 or A-490 designation. It is equally important that high strength bolts must be used with nuts and washers that are compatible with the bolt material.

For A-325 bolts (Types 1 and 2, plain, uncoated), this usually means using a nut conforming to ASTM A563 (Grade C, C3, D, DH or D3, plain), or ASTM A194 (Grade 2 or 2H, plain).

For A-490 bolts (Types 1 and 2, plain), nuts conforming to ASTM A563 (Grade DH or DH3, plain) or ASTM A194 (Grade 2H, plain) are usually used. In either case, hardened flat washers conforming to ASTM F436 must be used under the turned part. Spring type lock washers are not recommended for high strength bolted connections as they have a tendency to spread apart during installation.

Note the following:

- a. AISE Technical Report No. 6, prohibits the use of low carbon bolts (ASTM A-307) for structural connections.
- b. As for maintenance, reuse of A490 bolts and galvanized A325 bolts is prohibited (retightening previously tightened bolts which have become loose by the tightening of adjacent bolts is not considered "reuse").

Bridge Girders

1. Crane bridges shall consist of welded sections with sufficient reinforcement constructed of rolled steel plates with minimum plate thickness of 6 mm.
2. The girders shall be designed with positive pre-camber, and the vertical deflection caused by the working load limit and the weight of the trolley in the central position shall not exceed 1/900 of the span.

End Trucks

1. The end trucks shall be motorized and shall have not less than 4 forged steel wheels with sealed, tapered roller bearings.

2. The end carriages shall be one piece welded construction and designed so that the weight of the crane and its load is equally divided between the wheels. These shall incorporate suitable drop stops to limit the fall of the crane more than 25 mm in the event of breakage of a track wheel, bogie or axle and designed to engage into the side of the rail in the event of guide roller failure, bringing the crane to a safe stop.
3. Each assembly shall have not less than four wheels. Sufficient wheels shall be provided to distribute the load on the track beams. Static wheel loading in pounds kilogram for cylindrical treads shall not exceed 1,200 DW [544 kg; 1,200 pounds] for crane Duty Classes A and B and 1,000 DW [454 kg; 1,000 pounds] for Duty Class C, where "D" equals the diameter of the wheel in inches or millimeter and "W" equals the nominal width of bearing on the tread.

Cross Travel Trolleys

1. The trolley shall be fabricated as an integral part of the hoisting mechanism or as an assembly bolted to a unit hoist.
2. Trolley wheels shall be flangeless type and carried on the specified type of antifriction bearings. The tractor frame shall include two guide rollers on each side of the frame, carried on sealed and permanently lubricated antifriction bearings.
3. Buffers shall be provided on the frame to engage the stops in the bridge structure. Where multiple hooks are installed, they are to be in-line and centered between the 2 crane girders.

Wheels

1. Flangeless wheels shall be used for long travel with side guide roller sets acting on both sides of the rail that is located on the power collector side of the crane. Wheels shall be carried on sealed, self-aligning, and permanently lubricated antifriction bearings designed for axial and thrust loading. Bearings shall be provided with fittings for pressure lubrication.
2. Non-corroding, non-sparking end truck wheels shall be AISI Type 304 corrosion-resistant steel or suitable copper alloy.

3. Wheel base of the end truck assembly for bridges with 4 pairs of wheels shall not be less than 1/7 of the bridge span; for bridges having 8 pairs of wheels, the center-to-center distance of the rocker pins on which the equalizer bar pivots shall not be less than 1/7 of the longest bridge span.
4. Safety lugs shall be provided to limit the drop to not more than 0.5 inch (12.7 mm) in case of wheel or axle breakage and to maintain the crane or trolley on the track beam.
5. Wheel Hardness rating shall be above 60 Rockwell C and shall be at least 25 to 30% harder than its corresponding rail.
6. As applicable to top running bridge cranes, wheels could be manufactured with tapers of 1 in 20, 1 in 25, or 1 in 16 and are generally used on bridge drives on long span cranes to help prevent skewing of the bridge structure. The tapered wheels should almost always be installed with the larger diameter towards the inboard side of the crane.

Rails

1. All long and cross travel rails shall be as per DIN 536-1 (or equivalent) and assembled as per German Standard VDI 3576 (or equivalent).
2. All rail section lengths shall be welded together to give a continuously welded rail between expansion joints; the welded method shall be either by Flash butt (resistance) or Aluminothermy method.

Cabs

1. An open operator's cab, when specified, shall be complete with cushioned seat, joystick, and operating controls and pushbuttons.
2. The general arrangement of the cab and the location of the control and protective equipment shall be such that all operating handles are within convenient reach of the operator when facing the area to be served by the load hook, or while facing the direction of travel of the cab. The arrangement shall allow the operator a full view of the load hook in all positions.
3. The clearance of the cab above the working floor or passageway should not be less than 7 feet.

Hoists

1. Hoist assembly shall include a hook, load block, wire rope and drum, gearing, brakes, motor drive and controls with integral or attached trolley.
2. The hoist shall have two independent means of braking; a holding brake which shall be applied automatically on power removal and controlled braking to prevent speeding when lowering the load.
3. Electric hoists wiring, contact conductors, controls, overcurrent protection and grounding shall conform to NFPA 70 and to the applicable UL standards and specified requirements. Each unit shall be factory-wired and ready for operation.

Bearings

1. Bearings in the hoist mechanism shall be precision manufactured antifriction bearings, needle-type roller bearings or end and radial thrust ball bearings, operating in an oil bath, as per the requirements specified.
2. Exposed & load block bearings shall be pre-lubricated and factory sealed.
3. Hook bearings shall be of the thrust type, designed on the basis of hours of life and load for the applicable hoist duty class at an arbitrary speed of 10 revolutions per minute. Dead load and hook load shall be reduced to a percentage with normal impact, shock, and similar loadings omitted.
4. Percentage of dead load and hook load, the applicable L-10 standard ABMA 9, and rating life of bearings in hours, as applicable to the crane duty class, shall be as follows:

Crane Duty Class	Hoist Rating		Trolley Rating		Bridge Rating	
	Life*	Load	Life*	Load	Life*	Load
A	7000	75	5000	75	5000	75
B	7000	85	5000	75	7500	75
C	15000	75	10000	85	15000	85

*The L-10, rating life of a group of apparently identical ball bearings is defined as the number of revolutions (or hours at some given constant speed) that 90 percent of a group of bearings will complete or exceed before the first evidence of fatigue develops, ABMA 9.

Brakes

Automatic brakes shall be provided for all motions. Drum brakes are preferred on hoists and should have taper bores to mate to the gearbox/motor shafts. These shall be applied immediately when the current is switched off or fails from any cause. Brakes may be applied by mechanical, electrical, pneumatic, hydraulic, or gravity means.

1. **Motor Brakes** - Motor brakes shall be provided on electric-motor-operated hoists, trolleys and bridges. Motor brakes shall be externally adjustable, multiple friction electromagnetic disk brakes which shall apply automatically when the power is interrupted.

Torque rating of the bridge and trolley brakes shall be not more than 50 percent of the full-load torque of the bridge and trolley motors and shall be adjustable to 25 percent for all duty classes.

2. **Hoist Load Brake** - Each hoisting unit shall be provided with two means of braking. One brake shall be an electric motor brake as specified. The other brake shall be a mechanical load brake, directly applied to the hoist motor shaft or other shaft in the hoist gear reduction.

A hoist motor brake shall be capable of holding the capacity load of the hoist at any point independent of the load brake. In addition to stopping and safely holding 125 percent of the rated load from any operating speed, it shall hold a static load equal to 150 percent of the rated capacity.

Hoists handling molten metal shall be equipped with two holding brakes plus means for control braking. The additional holding brake shall be a direct acting hoist drum brake system that will arrest the hoist motion under full speed and full load.

3. **Eddy-Current Load Brake** - Eddy-current-type brake shall be provided for hoist control of wound-rotor motors. Eddy-current brakes shall provide an adjustable varying artificial load on 4 lowering speed points and on not less than 2 hoisting speed points.

When eddy current brakes and motors are not determined from root-mean-square computations, the crane torque rating of the eddy-current brakes shall be not less than 1.2 times the torque rating of the motor.

Trolley Stops -

1. They shall be provided at the limits of travel of the trolley.
2. They shall be fastened to resist forces applied when contacted.
3. A trolley stop engaging the tread of the wheel shall be of a height at least equal to the radius of the wheel.

Bumpers -

1. **Bridge Bumpers** - The bumpers shall be capable of stopping the crane (not including the lifted load) at an average rate of deceleration not to exceed 3 ft/s/s when traveling in either direction at 20 percent of the rated load speed. The bumpers shall have sufficient energy absorbing capacity to stop the crane when traveling at a speed of at least 40 percent of rated load speed.
2. **Trolley Bumper** - A trolley shall be provided with bumpers or other automatic means of equivalent effect for stopping the trolley. The bumpers shall be capable of stopping the trolley (not including the lifted load) at an average rate of deceleration not to exceed 4.7 ft/s/s when traveling in either direction at 1/3 of the rated load speed.

Walkways -

1. Walkways shall be furnished on all top-running cranes. A full-length walkway shall be provided for access to the bridge drive, crane control mechanism, bridge span conductor system and lube fittings.
2. A short walkway shall also be provided at the opposite side of the bridge girders for access to the festoon cables. All walkways shall include handrails, toe plates and all required OSHA safety devices.

Lubrication -

1. Means shall be provided for adequate lubrication of moving parts of the crane bridge hoist and trolley, and for filling, draining, and checking the level of the lubricant.
2. Lubricant shall conform to AGMA 250.04 type as recommended by the manufacturer.
3. Vertical gear trains shall be provided with positive lubrication to the upper gears and to oil-lubricated bearings. Enclosed reduction gearing and automatic load lowering brakes shall be lubricated in an oil bath.
4. Gear reduction at trolley and bridge wheels for cranes of Duty Classes A and B may be of open design and grease lubricated. Trolley and bridge wheel gears on Duty Class C cranes shall run in oil.
5. Grease-lubricated bearings shall be lubricated through individual pressure lines to each bearing. Each line shall be equipped with a lubrication fitting.

Guards -

1. If hoisting ropes run near enough to other parts to make fouling or chafing possible, guards shall be installed to prevent this condition.
2. Exposed moving parts such as gears, set screws, projecting keys, chains, chain sprockets, and reciprocating components, which might constitute a hazard under normal operating conditions, shall be guarded.

Clearance from obstruction -

1. Minimum clearance of 3 inches overhead and 2 inches laterally shall be provided and maintained between crane and obstructions in conformity with Specification No. 61 CMAA.
2. Where passageways or walkways are provided, obstructions shall be avoided so that the safety of personnel is not jeopardized by movements of the crane.

Foot walks & Ladders -

1. If sufficient headroom is available on cab-operated cranes, a foot walk shall be provided on the drive side along the entire length of the bridge of all cranes having the trolley running on top of the girders.
2. Foot walks should be located to give headroom not less than 78 inches. In no case shall less than 48 inches be provided. If 48 inches of headroom cannot be provided, foot walks should be omitted from the crane and a stationary platform or landing stage should be built for workers making repairs.
3. Foot walks shall be of rigid construction and designed to sustain a distributed load of at least 50 pounds per square foot.
4. Foot walks shall have a walking surface of anti-slip type; wood will meet this requirement.
5. Foot walks should be continuous and permanently secured.
6. Foot walks should have a clear passageway at least 18 inches wide except opposite the bridge motor, where they should be not less than 15 inches. The inner edge shall extend at least to the line of the outside edge of the lower cover plate or flange of the girder.
7. All foot walks shall be provided with handrails and toe-boards.

Ladders and stairways -

1. Access to the cab and/or bridge walkway shall be by a conveniently placed fixed ladder, stairs, or platform requiring no stepping over any gap exceeding 12 inches.
2. Fixed ladders shall be in conformance with the American National Standards Institute, Safety Code for Fixed Ladders, ANSI A14.3-1956.
3. Stairways shall be equipped with rigid and substantial metal handrails. Walking surfaces shall be of an anti-slip type.

Fire extinguisher -

A carbon dioxide, dry-chemical, or equivalent hand fire extinguisher should be kept in the cab. Carbon tetrachloride extinguishers shall not be used.

Lighting -

Light in the cab and the work area shall be sufficient to enable the operator to see clearly enough to perform the work.

ELECTRICAL & CONTROL

Electric Equipment -

1. All wiring and equipment shall comply with Article 610 of ANSI/NFPA No. 70, National Electrical Code.
2. The control circuit voltage shall not exceed 600V for AC or DC.
3. The control circuit voltage in pendant push-buttons shall not exceed 150V for AC or 300V for DC.
4. Where multiple conductor cable is used with a suspended push-button station, the station shall be supported so that the electrical conductors are protected from strain.
5. Pendant control stations shall be constructed to prevent electrical shock. The push-button enclosure shall be at ground potential and marked for identification of functions.

Motor Controller -

1. Motors and controls shall conform to CMAA 70 or CMAA 74. Motor mounting, shaft and keyway dimensions shall conform to the manufacturer's standards.
2. Class I crane controllers are intended for use with all Crane Manufacturers Association of America (CMAA) crane service classes except A and B.
3. Class II crane controllers are intended for use with CMAA crane service classes A and B (infrequent use or light industrial service).
4. Controllers for variable speed motors shall be provided with 5 speed points, not less than 3 of which shall be hand-controlled points. When provided with 3 hand-controlled points, points 1, 2, and 5 shall be the hand-controlled points, and points 3 and 4 shall be automatic.

5. Accelerating relays, adjustable from at least 1/4 second to 2 seconds, shall be provided.
6. Magnetic motor controllers shall be capable of interrupting operating overloads up to and including 10 times their normal motor rating. Continuous current ratings shall be based on temperature rise above an ambient temperature of 104°F (40°C). Core and coil assembly, auxiliary contacts, and other control-circuit devices shall be rated at 120 volts.

Resistors -

1. Resistors shall have a thermal capacity of not less than Class No. 150 series and shall be rated for continuous duty. Accelerating resistors shall be rated for Duty Classes A & B cranes, hoists, and trolleys: 15 seconds on and 45 seconds off AND for Duty Class C: 15 seconds on and 30 seconds off.
2. Resistors for variable-speed bridge motors shall provide not more than 25-percent full-load motor torque for the first speed point of bridge travel.
3. Resistors for variable speed hoists and trolley motors shall provide not more than 50-percent full-load motor torque for the first (slow)-speed point hoisting and not more than 25 percent for the first-speed point of trolley travel.
4. Resistors shall be designed for operation within temperature ratings of 707°F (375°C), ambient plus rise when wires are bare, and 572°F (300°C) when embedded. Resistors shall be of the non-breakable, non-corroding, wound type capable of adjustment by taps and shall be thoroughly ventilated. Resistors shall be mounted in substantial end frames and shall be enclosed in louvered enclosures for both indoor and outdoor service.
5. Resistors shall be non-breakable and mounted in ventilated enclosures.

Disconnect Switch, Conduit, and Wiring-

1. Feed-in boxes for the attachment of feeder conductor to runway conductor shall consist of bus tap connections for terminal lugs without over current protection in a protective enclosure.

2. Enclosures shall be formed from cast iron, corrosion-resistant steel, or carbon steel with metal thickness and box dimensions in accordance with UL 857. Seams and joints shall be closed and reinforced with flanges formed of the same material from which the box is made. The box shall be provided with a screwed-on cover plate. A carbon-steel enclosure shall be zinc coated after fabrication with Type SC3 minimum thickness of coating in accordance with ASTM B 633.
3. Enclosures shall be of made of the same type material and paint finish of NEMA enclosures as specified herein.
4. Disconnect switches shall be a surface-mounted, heavy-duty, single-throw, air-break, enclosed type conforming to NEMA KS 1 as indicated below.
5. Switch boxes shall be installed with the centerline 66 in (1,675 mm) above the finished floor and at the approximate center of the crane runway length.
6. Conduits between monorail feeder enclosures and disconnect switches and fixed control stations shall be zinc-coated, rigid-steel conduits, couplings, elbows, bends, and nipples conforming to ANSI C80.1. Zinc coating shall be an electrodeposited coating conforming to ASTM B 633.
7. Building wires for use in conduits, raceways, and wire ways in wet or dry locations shall be single-conductor, 600-volt, heat and moisture resistant with a maximum temperature rating of 167°F (75°C), or cross-linked thermosetting polyethylene insulation with a temperature rating of 194°F (90°C).
8. Switchboard wires shall run vertically and horizontally only and in such manner that each wire is accessible and firmly supported. Bus bars shall be made of hard-drawn rectangular copper with silver-plated contact surfaces. Buses shall be rigidly supported and spaced to provide ample room for connecting cables and to prevent arcing.
9. Wiring, except panel wiring, shall be protected by drained or moisture tight, zinc-coated, rigid conduits. Flexible leads, where required, shall be enclosed in moisture proof flexible steel conduits. Crane complex wiring

and conduits shall be arranged for a minimum of wiring during assembly and construction on site. Junction boxes shall be provided, where practical.

Switches -

1. On cab-operated cranes a switch or circuit breaker of the enclosed type, with provision for locking in the open position shall be provided in the leads from the runway conductors. A means of opening this switch or circuit breaker shall be located within easy reach of the operator.
2. On floor-operated cranes, a switch or circuit breaker of the enclosed type, with provision for locking in the open position, shall be provided in the leads from the runway conductors. This disconnect switch shall be mounted on the bridge or footwalk near the runway collectors.

Electrical Safety Provisions -

1. Electrification systems for power distribution from the source of supply to mobile tap-off devices on a crane runway and crane bridge shall be complete with unit length conductors, insulating conductor covers, insulators, splices and splice covers, end caps, support brackets and fasteners, current collectors, expansion, isolation and power-interrupting sections, disconnect switches, and conduit and wiring to power takeoff point.
2. Protective devices shall conform to NEMA ICS 1 and shall include a fused circuit switch for each motor controller, a main-line magnetic contactor incorporating under voltage protection, main overload protection, and motor overload protection. Two overload relays shall be provided for each 3-phase motor winding.
3. Operation of any protective device (overload, under voltage, control circuit fuse, or stop pushbutton) shall stop motions. Fuses shall be of the nonrenewable cartridge type. Each hoist shall be provided with under voltage and overload protection in accordance with NEMA ICS 1. Overload relays of inverse-time characteristics shall be provided. Under voltage protection shall be provided for cranes of Duty Class C. Overload

relays shall be connected in each phase of a 3-phase, AC circuit. Control circuit shall be fused.

4. An emergency stop button and a reset button shall be provided to operate the main-line contactor.
5. Controller component ratings shall conform or be in proportion to the tabulated ratings of NEMA ICS 1. All contactors shall be provided with arc shields or suppressors or the contacts shall be enclosed in an arc box.
6. Over-current protection shall consist of externally operable, manual reset, thermal-overload relays in each pole of the controller. Thermal overload relays shall be melting alloy or bimetallic, nonadjustable type with continuous current ratings and service-limit current ratings in accordance with Section 2, Part 2-321A of NEMA ICS 1.
7. Phase loss protection shall be provided.
8. Conduit and fittings shall be rigid galvanized steel. Liquid tight flexible steel conduit will be acceptable on trolleys and short runs.
9. The cranes shall be electrically grounded through the runway rails and building columns. Separate runway grounding (fourth rail) is not required.

Controls Safety Provisions -

1. Motion warning devices, both audible (siren or horn) and visual (rotating lights) shall be provided and shall operate continuously with either bridge or trolley motion.
 2. Cranes shall be designed for stepless remote control using a portable radio transmitter and a pendant push button control. The pendant shall have a fixed reel where the cable can be stored until required.
 3. Over-hoisting and over-traveling limit switches shall be provided for all cranes motions.
 4. All limit switches shall automatically reset allowing an opposite directional movement to be selected to that which activated the limit switch.
-

PART - 7 INSPECTION & TESTING REQUIREMENTS

In this section we will discuss the following:

- ❖ Key Crane Inspection Areas
- ❖ OSHA Inspection Requirements
- ❖ Testing Requirements

Why Inspections are needed?

Inspection of overhead cranes is crucial to personnel and equipment safety. There are three inspection classifications as follows:

1. Initial inspection is performed upon initial installation.
2. Frequent inspections shall be performed on a monthly basis.
3. Periodic inspections shall be performed on a yearly basis.

ASME B30.16 requires operators to visually examine hoist equipment before using it. Volume B30.16 includes provisions that apply to the construction, installation, operation, inspection, testing, and maintenance of chain and wire rope hoists used for, but not limited to, vertical lifting and lowering of freely suspended, unguided loads which consist of equipment and materials.

Key Crane Inspection Areas:

Inspections may be broken down into systems as follows:

Mechanical

- Brakes (not including the actuators)
- Brake lining
- Gear Boxes
- Drive (End) Trucks
- Drive Shafts, etc.

Structural

- Runway

- Rails
- Bridge Girders, etc.

Electrical

- Motors
- Controllers
- Brake actuators
- Bus Bars
- Electrical Cabinets
- Hydraulic/Pneumatic
- Brake Actuators
- Master Cylinder, etc.

Inspection Records

Dated inspection reports or comparable records shall be made on critical items such as hoisting machinery, sheaves, hooks, chains, ropes, and other lifting devices as covered under Periodic Inspections. Records shall be placed on file.

Records for overhead crane inspections are maintained by the O&M group and are available for review by crane operators.

What Regulations Apply?

The Occupational Safety and Health Association (OSHA) requires crane inspections at set intervals based on crane classification. However, more frequent inspections can provide added assurance and improved productivity. Each inspection should end with a written report on the crane's condition, including a list of any needed repairs and a timetable for completion.

OSHA Regulations for Crane Inspections

Crane Service Class	Definition	Minimum OSHA Inspection	Typical Preventive Maintenance Schedule
A	Standby or infrequent service	Annually or semi-annually	Semi - annually
B	Light service	Annually	Quarterly
C	Moderate service	Annually	Bi-monthly
D	Heavy service	Semi - annually	Monthly
E	Severe service	Quarterly	Twice a month
F	Continuous severe service	Quarterly	Weekly

Additional inspections may be required due to the hours of operation, conditions of the environment, and/or severity of the service. The inspection requirements of ANSI (B30.2, B30.11 and B30.17) and the manufacturer must also be followed.

TESTING REQUIREMENTS

Crane test loads are typically specified at 125% of the rated capacity by both OSHA and ASME. Neither standard, however, specify an acceptable tolerance over or under the 125% figure. The only reference to such a tolerance was given in an interpretation by ASME B30.2. Though not considered a part of the standard, this interpretation suggested a tolerance of +0%/-4% on the weight of the test load. In fact, this suggested a test load weighing between 120% and 125% of the rated crane capacity (i.e.: $125\% - (125\% \times .04) = 120\%$).

A bridge, gantry or overhead traveling crane installed after January 1, 1999, or such a crane or its runway which has been significantly modified, must be load tested before being put into service as follows:

1. All crane motions must be tested under loads of 100% and 125% of the rated capacity for each hoist on the crane, and the crane must be able to safely handle a load equal to 125% of the rated capacity;
2. All limit-switches, brakes and other protective devices must be tested when the crane is carrying 100% of the rated capacity;
3. Structural deflections must be measured with loads of 100% and 125% of the rated capacity and must not exceed the allowable deflections specified by the applicable design standard;
4. The load must be traveled over the full length of the bridge and trolley runways during the 100% and 125% load tests, and only the parts of runways that have been successfully load tested may be placed into service.
5. A record of all load tests must be included in the equipment record system giving details of the tests and verification of the loads used, and be signed by the person conducting the tests.
6. A replacement crane or hoist to be installed on an existing runway may be load tested in the manufacturer's facility and installed on an existing runway provided that the replacement unit has a rated capacity and gross weight equal to or less than the previously tested rating for the runway, and the runway need not be load tested unless it has been modified since it was previously load tested.

Appendix - A

KEY WORDS AND DEFINITIONS

A

1. **ABNORMAL OPERATING CONDITIONS** - Environmental conditions that are unfavorable, harmful or detrimental to or for the operation of a hoist, such as excessively high (over 100°F) or low (below 0°F) ambient temperatures, corrosive fumes, dust laden or moisture laden atmospheres, and hazardous locations.
2. **ACCESS PLATFORM** - A limited length platform located on the idler girder to access to the end truck wheels only.
3. **ADJUSTABLE OR VARIABLE VOLTAGE** - A method of control by which the motor supply voltage can be adjusted.
4. **AMBIENT TEMPERATURE** - The temperature of the atmosphere surrounding the hoist.
5. **AUTOMATIC CRANE** - A crane which when activated operates through a preset cycle or cycles.
6. **AUXILIARY HOIST** - A supplemental hoisting unit, usually designed to handle lighter loads at a higher speed than the main hoist.
7. **AUXILIARY GIRDER (OUTRIGGER)** - A girder arranged parallel to the main girder for supporting the platform, motor base, operator's cab, control panels, etc., to reduce the torsional forces such load would otherwise impose on the main girder.
8. **AXLE, FIXED** - A shaft which is fixed in the end truck and about which the wheel revolves.
9. **AXLE, ROTATING** - A shaft which is fixed in the wheel and which rotates on bearings fixed in the end truck.

B

10. **Bearing Life (L-10)** - The L-10 life of an anti-friction bearing is the minimum expected life (hours) of 90 percent of a group of bearings which are

operating-at a given speed and loading. The average expected life of the bearings is approximately five times the L-10 life.

11. **BEARING LIFETIME LUBRICATED** - An antifriction bearing which is provided with seals and a high-stability oxidation-resistant grease to permit operation of the bearing without relubrication for not less than the specified B-10 life.
12. **BASE or DECK MOUNTED (HOIST)** - A type of mounting where the hoist is mounted to the top side of a horizontal supporting surface.
13. **BHN** - Brinell hardness number, measurement of material hardness.
14. **BLOCK, LOAD** - The assembly of hook, swivel, bearings, sheaves, pins and frames suspended from the hoisting ropes. In a "short type" block, the hook and the sheaves are mounted on the same member, called the swivel. In a "long type" block, the hook and the sheaves are mounted on separate members. (The supporting member for the sheaves is called the sheave pin and the supporting member for the hook is called the trunnion).
15. **BLOCK, UPPER** - A fixed assembly of sheaves, bearings, pins and frame, located on the trolley cross members, and which supports the load block and its load by means of the ropes.
16. **BOGIE** - A short end truck attached to the end of one girder (or to a connecting member if more than one bogie is used per girder). This type of end truck is used when more than 4 wheels are required on a crane due to the design of the runway.
17. **BOGIE, EQUALIZING** - A short end truck which is flexibly connected to one girder (or connecting member) by means of a pin upon which the truck can oscillate to equalize the loading on the two truck wheels. This construction uses a very rigid end tie between the girders.
18. **BOGIE, FIXED** - A short end truck which is rigidly connected to one girder. A flexible end tie is used between the girders to permit equalization of the wheel loads by torsional deflection of the girders and flexing of the end tie.
19. **BOOM (OF GANTRY CRANE)** - An extension of the trolley runway that may be raised or retracted to obtain clearance for gantry travel.

20. **BOOM (OF OVERHEAD CRANE)** - A horizontal member mounted on the trolley to permit hoisting and lowering the load at a point other than directly under the hoist drum or trolley.
21. **BOX SECTION** - The rectangular cross-section of girders, trucks or other members enclosed on four sides.
22. **BRAKE** - A device, other than a motor, used for retarding or stopping motion by friction or power means.
23. **BRAKE, CONTROL** - A method of controlling speed by removing energy from the moving body or by imparting energy in the opposite direction.
24. **BRAKE, COUNTER TORQUE** - A method of control by which the power to the motor is reversed to develop torque in the direction opposite to the rotation of the motor using the motor as a generator, with the energy being dissipated by resistance.
25. **BRAKE, DRAG** - A friction brake that provides a continuous retarding force having no external control.
26. **BRAKE, DYNAMIC** - A method of controlling speed by block, or loading the assembly of hook or shackle, swivel bearing, sheaves, sprockets pins, and frame suspended by the hoisting rope or load chain. This shall include any appurtenances reeved in the hoisting rope or load chain.
27. **BRAKE, EDDY CURRENT** - A device for controlling load speed in the hoisting or lowering direction by placing a supplementary load on the motor. This load results from the interaction of magnetic fields produced by an adjustable direct current in the stator coils and induced currents in the rotor.
28. **BRAKE, MECHANICAL LOAD** - A friction device, usually using multiple discs, used for controlling load speed in the lowering direction only. The brake prevents the load from overhauling the motor.
29. **BRAKE, HOLDING** - A friction brake for a hoist, that is automatically applied to prevent motion when power is off.
30. **BRAKE, PARKING** - A friction brake for bridge or trolley, automatically applied when power to the crane is interrupted.

31. **BRAKE, REGENERATIVE** - A method of controlling speed in which the electrical energy generated by the motor is fed back into the power system.
32. **BRAKE, SERVICE** - A friction brake for bridge or trolley, automatically or manually applied, used during normal operation to apply a retarding force.
33. **BRANCH CIRCUIT** - The circuit conductors between the final over current device protecting the circuit and the outlet(s).
34. **BRAKEAWAY FORCE** - The external force that is required to separate the vacuum pad or vacuum lifting device from the load when applied perpendicular to the attachment surface.
35. **BRIDGE** - That part of an overhead crane consisting of girders, trucks, end ties, as well as a walkway and drive mechanism which carries the trolley and travels in a direction parallel to the runway.
36. **BRIDGE CRANE** - is the entire assembly as a functioning unit of end trucks, beak, trolley, hoist, electrification, control panel, end stops, bumpers, drives, gear boxes and festooning.
37. **BRIDGE CRANE SPAN** - is the distance from center of rail on one runway to center of rail on the other runway side. For under running cranes, this dimension is measured from the runway beam centers as opposed to rail centers.
38. **BRIDGE CONDUCTORS** - The electrical conductors located along the bridge structure of a crane to provide power to the trolley.
39. **BRIDGE GIRDER** - Crane member on which carriers or trolleys travel, horizontally mounted between and supported by the end trucks.
40. **BRIDGE RAIL** - The rail supported by the bridge girders on which the trolley travels.
41. **BRIDGE STRUCTURE** - The structural members of a building which support the building loads and on which the loads of crane or monorail equipment, and the material to be moved, will be imposed.
42. **BUMPER (BUFFER)** - An energy absorbing device for reducing impact when a moving crane or trolley reaches the end of its permitted travel, or when

two moving cranes or trolleys come into contact. This device may be attached to the bridge, trolley or runway stop.

C

- 43. **CAB** - The operator's compartment on a crane
- 44. **CAB-OPERATED CRANE** - A crane controlled by an operator in a cab located on the bridge or trolley.
- 45. **CAMBER** - The slight, upward, vertical curve given to girders to partially compensate for deflection due to rated load and weight of the crane parts. Camber, in and by itself, in no way relates (significantly) to the strength of the girder. Its sole purpose is to control girder deflection relative to the horizontal. Negative camber may be an indication of some failure in the structure, typically (but not exclusively) on the bottom tension flange of the girder.
- 46. **CAPACITY** - The maximum rated load (in tons) which a crane is designed to handle.
- 47. **CLEARANCE** - Minimum distance from the extremity of a crane to the nearest obstruction.
- 48. **CMAA** - Crane Manufacturers Association of America, Inc. (Formerly EOICI-Electric Overhead Crane Institute).
- 49. **COLLECTORS** - Contacting devices for collecting current from the runway or bridge conductors. The mainline collectors are mounted on the bridge to transmit current from the runway conductors, and the trolley collectors are mounted on the trolley to transmit current from the bridge conductors.
- 50. **COLLECTORS, (Shoe)** - The portion of a collector which makes contact by sliding on the conductor bar.
- 51. **COLLECTORS, (Wheel)** - The portion of a collector which makes contact by rolling on the conductor bar.
- 52. **COLLECTORS, (Current)** - Contacting devices for collecting current from runway or bridge conductors.

53. **COLLECTOR, RUNWAY** - A contacting device for obtaining electrical current from the runway conductors. The runway collectors are mounted from the bridge.
54. **COLLECTOR, TROLLEY** - A contacting device for obtaining electrical current from the bridge conductors. The trolley collectors are mounted from the trolley. (Sometimes they are incorrectly called bridge collectors.)
55. **CONDUCTORS, BRIDGE** - The electrical conductors located along the bridge girder(s) to provide power and control circuits to the trolley. (Sometimes they are incorrectly called trolley conductors.)
56. **CONDUCTORS, RUNWAY** - The electrical conductors located along the runway to provide power to the entire crane.
57. **CONTACTOR, MAGNETIC** - An electro-magnetic device for opening and closing an electric power circuit.
58. **CONTROL BRAKING MEANS** - A method of controlling lowering speed of the load by removing energy from the moving load or by imparting energy in the opposite direction. The various options for braking include:
- **COUNTERTORQUE** - A method of control by which the power to the motor is reversed to develop torque in the opposite direction to the rotation of the motor.
 - **DYNAMIC** - A method of controlling speed by using the motor as a generator, with the energy being dissipated in resistors.
 - **EDDY CURRENT** - A method of controlling or reducing speed by means of an electrical induction load brake.
 - **MECHANICAL** - A method of controlling or reducing speed by friction.
 - **REGENERATIVE** - A method of control in which the electrical energy generated by the motor is fed back into the power system.
59. **CONTROLLER** - A device for regulating in a pre-determined way the power delivered to the motor or other equipment.
60. **CONTROLLER, MANUAL** - A controller having all of its basic functions performed by devices which are operated by hand.

61. **CONTROL PANEL** - An assembly of electrical components (magnetic or static) which governs the flow of power to or from a motor in response to signals from a master switch, pushbutton station, or remote control.
62. **COUNTER-TORQUE** - A method of control by which the motor is reversed to develop power to the opposite direction.
63. **COUPLINGS (Splices)** -Mechanical devices used to join the adjacent ends of track sections.
64. **COVER PLATE** - The top or bottom plate of a box girder.
65. **CRANE** - A machine for lifting and lowering a load and moving it horizontally, with the hoisting mechanism an integral part of the machine.
66. **CRANE, CAB OPERATED** - A crane controlled by an operator in a cab attached to the bridge or trolley.
67. **CRANE, FLOOR OPERATED** - A crane which is controlled by a means suspended from the crane, with the operator on the floor or on an independent platform.
68. **CRANE, GANTRY** - A crane similar to an overhead crane except that the bridge is rigidly supported on two or more legs.
69. **CRANE, HOT MOLTEN MATERIAL HANDLING (LADLE)** - An overhead crane used for transporting or pouring molten material.
70. **CRANE, MANUALLY OPERATED** - A crane whose hoist mechanism is driven by pulling an endless chain, and/or whose travel mechanism is driven in the same manner or by manually moving the load or hook in a horizontal direction.
71. **CRANE, OUTDOOR STORAGE GANTRY** - A special type of gantry crane of long span and with long legs, usually used for the storage of bulk material such as ore, coal, limestone, or sand. This type of crane normally will have one or two cantilevered girder ends with through legs.
72. **CRANE, OVERHEAD** - A crane with a single or multiple girder movable bridge, carrying a movable trolley or fixed hoisting mechanism, and traveling on an overhead fixed runway structure.

73. **CRANE, POLAR** - An overhead or gantry type crane which travels on a circular runway.
74. **CRANE, REMOTE OPERATED** - A crane controlled by an operator located other than on the crane and by any method other than a means suspended from the crane. Radio control is the most common means of remote operation.
75. **CRANE, SEMI-GANTRY** - A gantry crane with one end of the bridge supported on one or more legs and the other end of the bridge supported by an end truck connected to the girders and running on an elevated runway.
76. **CRANE SERVICE, (HEAVY)** - Service that involves operating at 85 to 100% of rated load or in excess of 10 lift cycles/hr as a regular specified procedure.
77. **CRANE SERVICE, (NORMAL)** - Service that involves operating at less than 85% of the rated load and not more than 10 lift cycles/hr except for isolated instances.
78. **CRANE, TRAVELING** - Cranes that follow a fixed path
79. **CREEP SPEED** - A very slow, constant, continuous, fixed rate of motion of the hoist, trolley, or bridge: usually established at 1% to 10% of the normal full load speed.
80. **CROSS SHAFT** - The shaft extending across the bridge, used to transmit torque from motor to bridge drive wheels.
81. **CUSHIONED START**- An electrical or mechanical method for reducing the rate of acceleration of a travel motion.

D

82. **DEAD LOADS:** The loads on a structure that remain in a fixed position relative to the structure. On a crane bridge such loads include girders, foot walk, cross shaft, drive units, panels, etc.
83. **DEFLECTION** – Displacement due to bending or twisting in a vertical or lateral plane, caused by the imposed live and dead loads. For bridge

cranes that value is considered for total load conditions (i.e. lifted load + trolley weight + bridge dead load).

84. **DEFLECTION CRITERIA (Vertical)** - is a maximum permissible deflection ratio allowed for a lifting device. For bridge cranes this value is $L/700$ and for jibs this value is $R/300$, where L is the span of the bridge crane and R is the reach of a jib crane.
85. **DEFLECTION CRITERIA (Horizontal)** – is a maximum permissible deflection ration allowed for a bridge crane or runway; usually specified limits are $L/600$ where L is the span of the bridge crane.
86. **DEFLECTION, DEAD LOAD** - The vertical displacement of a bridge girder due to its own weight plus the weight of parts permanently attached thereto, such as footwalk, drive mechanism, motor and control panels. The dead load deflection is fully compensated for in the girder camber.
87. **DEFLECTION, LIVE LOAD** - The vertical displacement of a bridge girder due to the weight of the trolley plus the rated load.
88. **DIAPHRAGM** - A vertical plate (or channel) between the girder webs, which serves to support the top cover plate and bridge rail and to transfer the forces of the trolley wheel loads to the webs.
89. **DRIFT POINT** - A control point on a travel motion which releases the electric brake without energizing the motor.
90. **DRIVE** - The assembly of the motor and gear unit used to propel the bridge or trolley
91. **DRIVE GIRDER** - The girder on which the bridge drive machinery is mounted.
92. **DRUM** - The cylindrical member around which the hoisting ropes are wound for lifting or lowering the load.
93. **DUMMY CAB** - An operator's compartment or platform on a pendant or radio controlled crane, having no permanently mounted electrical controls, in which an operator may ride while controlling the crane.
94. **DUTY CLASS-** is a method of distinguishing the usage of a crane, from a load and/or cycle point of view.

E

95. **EDDY-CURRENT BRAKING** - A method of control by which the motor drives through an electrical induction load brake.
96. **EFFICIENCY OF GEARING AND SHEAVES-** The percentage of force transmitted through these components that are not lost to friction.
97. **ELECTRIC OVERHEAD TRAVELING CRANE** - An electrically operated machine for lifting, lowering, and transporting loads, consisting of a movable bridge carrying a fixed or movable hoisting mechanism and traveling on an overhead runway structure.
98. **ELECTRICAL BRAKING SYSTEM** - A method of controlling crane motor speed when in an overhauling condition, without the use of friction braking.
99. **ENCLOSED CONDUCTOR(S)** - A conductor or group of conductors substantially enclosed to prevent accidental contact.
100. **ENCLOSURE** - A housing to contain electrical components, usually specified by a NEMA classification number.
101. **END APPROACH:** The minimum horizontal distance, parallel to the runway, between the outermost extremities of the crane and the centerline of the hook.
102. **END TIE** - A structural member other than the end truck that connects the ends of the girders to maintain the square-ness of the bridge.
103. **END TRUCK** - An assembly consisting of structural members, wheels, bearings, axles, etc., which supports the bridge girder(s) or the trolley cross member(s).
104. **EQUIVALENT DURABILITY WHEEL LOAD** is used to express the wheel loads that account for duty rating and wheel RPM. This value is generally less than the service wheel load.
105. **EQUALIZER** - A sheave or bar which compensates for unequal length or stretch of the hoisting rope(s) or swinging of the load block.
106. **EXPOSED** - Capable of being contacted inadvertently (applies to hazardous objects not adequately guarded or isolated).

F

107. **FAIL-SAFE** - A provision designed to automatically stop or safely control any motion in which a malfunction occurs.
108. **FESTOONING** – is a free floating flat cable that travels on a C-rail and provides direct contact for energizing hoist trolley movement. The contact is extremely wear resistant and provides advantage of superior reliability. This method is however not recommended for curves.
109. **FIELD WIRING** - The wiring required after erection of the crane.
110. **FIXED AXLE** - An axle that is fixed in the truck and on which the wheel revolves.
111. **FLEET ANGLE** - The angle formed by the wire rope and the drum groove or sheave groove in the plane which contains the wire rope and is parallel to the drum or sheave axis.
112. **FLOOR-OPERATED CRANE** - A crane which is pendant controlled by an operator on the floor or an independent platform.
113. **FOOTWALK** - A walkway with handrail and toeboards, attached to the bridge or trolley for access purposes.

G

114. **GANTRY CRANE** - A crane similar to an overhead crane except that the bridge for carrying the trolley or trolleys is rigidly supported on two or more legs running on fixed rails or other runways.
115. **GAUGE** - The horizontal distance center to center of the bridge rails.
116. **GIRDERS**- The principal horizontal beams of the crane bridge which supports the trolley and is supported by the end trucks.
117. **GIRDER, BRIDGE** - The principal horizontal beam(s) of the crane, which supports the trolley, is supported by the end trucks, and is perpendicular to the runway.
118. **GIRDER, DRIVE (GIRDER "A")** - the bridge girder to which the bridge motor and gearcase(s) are attached. For cranes having a drive on each

girder, it is the girder to which the control panels and/or the cab are attached.

- 119. **GIRDER, IDLER (GIRDER "B")** - The bridge girder which does not have the bridge drive attached, but which usually carries the bridge conductors.
- 120. **GIRDER, RUNWAY** - A horizontal beam attached to the building columns or wall, and supporting a runway rail on which the crane travels.
- 121. **GIRDER, AUXILIARY (OUTRIGGER)** - An additional girder, either solid or latticed, arranged parallel to the bridge girder(s) for supporting the footwalk, control panels, operator's cab, etc., to reduce the torsional forces such loads might otherwise impose.
- 122. **GROUND FAULT** - An accidental conducting connection between the electrical circuit or equipment and the earth or some conducting body that serves in place of the earth.

H

- 123. **HOIST** - A machinery unit that is used for lifting and lowering a load.
- 124. **HOIST, AUXILIARY** - A supplemental hoisting unit, usually designed to handle lighter loads at a higher speed than the main hoist.
- 125. **HOIST, MAIN** - The primary hoist mechanism provided for lifting and lowering the rated load of the crane.
- 126. **HOLDING BRAKE** - A brake that automatically prevents motion when power is off.
- 127. **HOOK APPROACH, END** - The minimum horizontal distance, parallel to the runway, between the centerline of the hook(s) and the face of the wall (or columns) at the end of the building.
- 128. **HOOK APPROACH, SIDE** - The minimum horizontal distance, perpendicular to the runway, between the centerline of a hook (main or auxiliary) and the centerline of the runway rail.
- 129. **HYDRAULIC BRAKE** - A brake that provides retarding or stopping motion by hydraulic means.

I

130. **IDLER GIRDER** - The bridge girder which does not have the bridge drive attached, but which usually carries the bridge conductors.
131. **IDLER SHEAVE** - A sheave used to equalize tension in opposite parts of a rope. Because of its slight movement, it is not termed a running sheave.
132. **INCH (INCHING)** - See "jog". Often used incorrectly to refer to "creep speed" (which see).
133. **INDUSTRIAL DUTY CRANE** - Service classification covered by CMAA Specification No.70, "Specifications for Electric Overhead Traveling Cranes".
134. **INSULATION CLASS** - Motor winding insulation rating which indicates its ability to withstand heat and moisture.
135. **INVERTER (VARIABLE FREQUENCY DRIVE)** - A method of control by which the fixed line voltage and frequency is changed to a three-phase system with infinitely variable voltage and frequency.

J

136. **JOG (INCH)** - To move the hook, trolley, or bridge in a series of short, discontinuous, increments by momentary operation of a controller.
137. **JIB CRANES**- are a type of crane that allows for rotational movement along with horizontal trolley motion and vertical hoisting motion. Jibs are normally mounted to a column or are free standing.

K

138. **KIP** - A unit of force, equivalent to 1000 pounds.
139. **KNEE BRACE** - The diagonal structural member joining the building column and roof truss
140. **KSI** - Kips per square inch, measurement of stress intensity.

L

141. **LATCH, HOOK** - A device used to bridge the throat opening of a hook.

142. **LEFTHAND END** - A reference to parts or dimensions on the viewer's left of the centerline of span, established when facing the drive girder side of the crane.
143. **LIFT (HOOK TRAVEL)** - The maximum vertical distance through which the hook(s) can move, as determined by the length of rope and/or the number of grooves on the drum.
144. **LIFT CYCLE** - Single lifting and lowering motion (with or without load).
145. **LIFTING DEVICES** - Devices which are not reeved on to the hoist ropes, such as hook-on buckets, magnets, grabs, and other supplemental units used for ease of handling certain types of loads. The weight of these devices is to be considered part of the rated load.
146. **LIMIT SWITCH** - A device designed to cut off the power automatically at or near the limit of travel for the crane motion.
147. **LINE CONTACTOR** - A contactor to disconnect power from the supply lines.
148. **LOAD, DEAD** - The load(s) on a portion of the crane, which remain(s) in a fixed position relative to the member being considered.
149. **LOAD, LIVE** - A load which moves or varies relative to the member being considered. For the trolley, the live load consists of the rated load plus the weight of the block. For the bridge, the live load consists of the rated load plus the weight of the trolley.
150. **LOAD, RATED** - The maximum static vertical load for which a crane or an individual hoist is designed.
151. **LOAD FLOAT** - A control system which enables stepless operation of a hoist in either the lifting or lowering direction for a range of about 0 to 5% of full rated speed, as well as permitting the load to be suspended stationary for a very short time with the holding brake(s) released.
152. **LOAD BLOCK** - The assembly of hook, swivel, bearing, sheaves, pins and frame suspended by the hoisting ropes.
153. **LOAD CARRYING PART** - Any part of the crane in which the induced stress is influenced by the load on the hook.

154. **LOAD CYCLE** - One lift cycle with load plus one lift cycle without load.

M

155. **MAGNETIC CONTROL** - A means of controlling direction and speed by using magnetic contactors and relays.

156. **MAIN LINE CONTACTOR** - A magnetic contactor used in the incoming power circuit from the main line collectors.

157. **MAIN LINE DISCONNECT SWITCH** - A manual switch that breaks the power lines leading from the main line collectors.

158. **MANUAL-MAGNETIC DISCONNECT SWITCH** - A power disconnecting means consisting of a magnetic contactor that can be operated by a remote pushbutton and can be manually operated by a handle on the switch.

159. **MASTER SWITCH** - A manually operated device that serves to govern the operation of contactors and auxiliary devices of an electric control.

160. **MATCH MARKING** - Identification of non-interchangeable parts for reassembly after shipment.

161. **MECHANICAL LOAD BRAKE** - An automatic type of friction brake used for controlling loads in the lowering direction. This unidirectional device requires torque from the motor to lower a load but does not impose additional load on the motor when lifting a load.

162. **MEAN EFFECTIVE LOAD** - A load used in durability calculations accounting for both maximum and minimum loads.

163. **MESSENGER TRACK** - A horizontal member, mounted along a handrail or girder, supporting movable carriers from which festooned wires are hung. The festooned wires may be used to transmit current from the bridge to the trolley or from the bridge to a pendant control unit.

164. **MILL DUTY CRANE** - Service classification covered by AISE Standard No. 6, "Specification for Electric Overhead Traveling Cranes for Steel Mill Service".

165. **MULTIPLE GIRDER CRANE** - A crane that has two or more girders for supporting the live load.

N

166. **NORMAL OPERATING CONDITIONS** - Those conditions during which a crane is being operated and is performing functions within the scope of the original design. For a cab operated crane, the operator is at the operating control devices in the cab and no other person is on the crane. For a floor operated crane, the operator is at the operating control devices, which are suspended from the crane but operated with the operator off the crane, and no person is on the crane. For a remote operated crane, the operator is at the operating control devices, which are not attached to any part of the crane, and no person is on the crane.
167. **NON-COASTING MECHANICAL DRIVE** - A drive with coasting characteristics such that it will stop the motion within a distance in feet equal to 10 percent of the rated speed in feet per minute when traveling at the rated speed with a rated load.

O

168. **OPERATOR'S CAB** - The operator's compartment from which movements of the crane are controlled. To be specified by the manufacturer as open, having only sides or a railing around the operator, or enclosed, complete with roof, windows, etc.
169. **OVERLOAD** - Any load greater than the rated load.
170. **OVERLOAD PROTECTION (OVERCURRENT)** - A device operative on excessive current to cause and maintain the interruption or reduction of current flow to the equipment governed.

P

171. **PENDANT**- Means suspended from the crane operating the controllers from the floor or other level beneath the crane.
172. **PITCH DIAMETER (ROPE)** - Distance through the center of a drum or sheave from center to center of a rope passed about the periphery.
173. **PLAIN REVERSING CONTROL**- A reversing control which has identical characteristics for both directions of motor rotation.

174. **PLUGGING** - A control function that accomplishes braking by reversing the motor line voltage polarity or phase sequence.
175. **PROTECTIVE PANEL**- An assembly containing overload and under voltage protection for all crane motions.
176. **PITCH DIAMETER** - The distance, measured through the center of a drum or sheave, from center to center of a rope, passed about the periphery of the drum or sheave.
177. **PLUG** - To operate a controller in such a manner that the motor line voltage polarity or phase sequence is reversed before the motor rotation has stopped, thereby developing a counter torque which acts as a retarding force.
178. **PLUGGING RELAY** - A current relay used on a bridge or trolley control panel which senses current in the motor secondary circuit of an alternating current motor and limits reverse torque of the motor to the first control point until the motor rotation has stopped. In a direct current control panel, the relay performs the same function by establishing a patented sensing circuit at the motor armature. (Sometimes called an anti-plugging relay.)

Q

179. **QUALIFIED** - A person who, by possession of a recognized degree, certificate of professional standing or who by extensive knowledge, training, and experience, has successfully demonstrated the ability to solve or resolve problems relating to the subject matter and work.

R

180. **RATED LOAD** - The maximum load that the crane is designed to handle safely as designated by the manufacturer.
181. **RAIL, RUNWAY** - The rail supported by the runway beams on which the crane travels.
182. **RAIL, BRIDGE** - The track supported by the bridge girder(s), on which the trolley travels.

183. **RAIL SWEEP** - A mechanical device attached to the end truck of a bridge or trolley, located in front of the leading wheels, to remove foreign objects from the rail.
184. **RATED CAPACITY**- is the maximum allowable load that can be safely lifted by a device without exceeding any design safety factors or fatigue limits.
185. **REGENERATIVE BRAKING** - A method of controlling speed in which electrical energy generated by the motor is fed back into the power system.
186. **REGULATED SPEED** - A function that tends to maintain constant motor speed for any load for a given speed setting of the controller.
187. **REMOTE OPERATED CRANE** - A crane controlled by an operator not in a pulpit or in the cab attached to the crane, by any method other than pendant or rope control.
188. **RESISTOR RATING** - Rating established by NEMA, which classifies resistors according to percent of full load current on first point and duty cycle.
189. **RIGHTHAND END** - A reference to parts or dimensions on the viewer's right of the centerline of span, established when facing the drive girder side of the crane.
190. **ROTATING AXLE** - An axle that rotates with the wheel.
191. **RUNNING SHEAVE** - A sheave that rotates as the hook is raised or lowered.
192. **RUNWAY** - The rails, beams, brackets and framework on which the crane operates.
193. **RUNWAY CONDUCTORS** - The main conductors mounted on or parallel to the runway that supplies current to the crane.

S

194. **SECONDARY VOLTAGE** - The induced open-circuit voltage in the rotor of a wound-rotor (slip-ring) motor at standstill, as measured across the slip rings with rated voltage applied to the primary (stator) winding.

195. **SHAFT, CROSS (SQUARING SHAFT) (DRIVE SHAFT)** - The shaft(s) extending the length of the bridge, used to transmit torque from the motor to a wheel(s) at each end of the bridge.
196. **SHALL** - When used in a Code or Standard, this word indicates that the rule is mandatory and must be followed. (See "should")
197. **SHEAVE** - A grooved wheel or pulley used with a rope or chain to change direction and point of application of a pulling force.
198. **SHOULD** - When used in a Code or Standard, this word indicates that the rule is a recommendation, the advisability of which depends on the facts in each situation. (See "shall")
199. **SIDE PULL** - The portion of the hoist rope pull acting horizontally when the hoist ropes are not operated vertically.
200. **SKEWING FORCES** - Lateral forces on the bridge truck wheels caused by the bridge girders not running perpendicular to the runways. Some normal skewing occurs in all bridges.
201. **SPAN** – Span is the distance from center of rail on one runway to center of rail on the other runway side. For under running cranes, this dimension is measured from the runway beam centers as opposed to rail centers.
202. **SPRING RETURN** - A device used on a manual controller, master switch, or pushbutton to cause the unit to return automatically to the neutral position, when released by the operator.
203. **STATIC CONTROL**- A method of switching electrical circuits without the use of contacts.
204. **STEPLESS CONTROL**- A type of control system with infinite speed control between minimum speed and full speed.
205. **STEPPED CONTROL** - A type of control system with fixed speed points.
206. **STOP**: A device to limit the travel of a trolley or crane bridge. This device normally is attached to a fixed structure and normally does not have energy absorbing ability.

207. **STRENGTH, AVERAGE ULTIMATE**- The average tensile force per unit of cross sectional area required to rupture the material as determined by test.
208. **SWEEP**- Maximum lateral deviation from straightness of a structural member, measured at right angles to the Y-Y axis.

T

209. **TEFC**- Totally enclosed fan cooled.
210. **TENV** - Totally enclosed non-ventilated.
211. **TOP RUNNING**- cranes run on crane rails mounted on runway beams.
212. **TORQUE, LOCKED-ROTOR** - The minimum torque which a squirrel-cage motor will develop at rest, for all angular positions of the rotor, with rated voltage applied at rated frequency. Not applicable to wound-rotor (slip-ring) motors.
213. **TORQUE, MOTOR BREAKDOWN** - The maximum torque which a squirrel-cage or wound-rotor (slip-ring) motor will develop with the rated voltage applied at the rated frequency, without an abrupt drop in speed.
214. **TORQUE, MOTOR FULL-LOAD** - The torque developed by an electric motor (AC or DC) to produce its rated horsepower at rated full-load speed.
215. **TORQUE, MOTOR PULL-UP** - The minimum torque developed by a squirrel-cage or wound-rotor (slip-ring) motor during the period of acceleration from rest to the speed at which breakdown torque occurs. For squirrel-cage motors with 8% or greater slip, the pull-up torque, the breakdown torque and the starting torque are all equal and occur at zero speed.
216. **TORSIONAL BOX GIRDER** - Girder in which the bridge rail is located over one web.
217. **TORSIONAL FORCES** - Forces which can cause twisting of a member.
218. **TROLLEY** - The unit carrying the hoisting mechanism which travels on the bridge rails.
219. **TROLLEY FRAME** - The basic structure of the trolley on which the hoisting and traversing mechanisms are mounted.

220. **TWO BLOCKING** - Condition under which the load block or load suspended from the hook becomes jammed against the crane structure preventing further winding up of the hoist drum.

U

221. **UNDER RUNNING** - cranes run on the lower flanges of runway beams. Local flange stresses due to runway wheel loads are considered by Mentor when designing runways beams. Mentor supplies these cranes for up to 20-ton capacities and 60-foot spans.

222. **UNDER VOLTAGE PROTECTION** - A device operative on the reduction or failure of voltage to cause and maintain the interruption of power in the main circuit.

223. **UPPER BLOCK** - A fixed assembly of sheaves, bearings, pins and frame, located on the trolley cross members, and which supports the load block and its load by means of the ropes

V

224. **VARIABLE FREQUENCY** - A method of control by which the motor supply voltage and frequency can be adjusted.

225. **VOLTAGE DROP** - The loss of voltage in an electric conductor between the supply tap and the load tap.

W

226. **WEB PLATE** - The vertical plate(s) connecting the upper and lower flanges or cover plates of a girder.

227. **WHEELBASE** - The distance from center-to-center of the outermost wheels of the bridge or trolley, measured parallel to the rail.

228. **WHEEL LOAD** - The service load for which the end truck wheels will experience when lifting the rated load.

229. **WHEEL LOAD, BRIDGE** - The vertical force (without impact) produced on any bridge wheel by the sum of the rated load, trolley weight and bridge weight, with the trolley so positioned on the bridge as to give maximum loading.

230. **WHEEL LOAD, TROLLEY** - The vertical force (without impact) produced on any trolley wheel by the sum of the rated load and the trolley weight.

Appendix - B

STEEL BUILDING USING CRANE – GLOSSARY OF TERMS

1. **Anchor Bolts** - Bolts utilized to secure building components to the foundation. In the case of primary framing, these bolts are embedded in the foundation and secured to the column base plate.
2. **Bay Spacing** - The distance between primary framing members measured parallel to the ridge or eave. Interior bays are measured from center line of frame to center line of frame.
3. **Building Height** - Building height is the eave height which usually is the distance from the bottom of the main frame column base plate to the top outer point of the eave strut. Eave height is the distance from the finished floor to the top outer point of the eave strut.
4. **Building Length** - The distance between the outside flanges of end wall columns in opposite end walls is considered the building length and is a combination of several bay lengths.
5. **Building Width** - The building width is defined as the distance from outside of the eave strut of one sidewall to outside of the eave strut of the opposite sidewall.
6. **Clear Height** - Distance from the finished floor to the bottom of the rafter at the rafter-to-column connection.
7. **Clear Span** - Distance between columns across the width of the building.
8. **Cold Formed Section** - A structural shape that is formed by bending thin gauge (typically 10-16 ga.) material at ambient temperature. This is typically done on a roll former.
9. **Column** - Vertical support member for primary framing system.
10. **Design Loads** - Design loads are the forces the building will be subjected to. Loads are applied in accordance with the latest building codes and standards applicable to pre-engineered buildings.

11. **Haunch** - The area of increased depth of the column or rafter member which is designed to account for the higher bending moments that occur at such places. Typically, this occurs at the rafter-to-column connection.
12. **Metal Building Systems** - Same as Steel Building System. Both terms are used to describe the same product.
13. **Post-and-Beam End frame** - A structural framing system utilized at the end wall which is composed of corner post, end post and rake beams.
14. **Pre-engineered Building** - Terminology previously used to describe Steel Building Systems (Metal Building Systems). This terminology was used when rigid frames were 'pre-engineered' for a desired load. Today, Steel Building Systems are custom engineered to meet the size and design loads to meet the customer's needs.
15. **Rafter** - A fabricated member that extends from the haunch member to the frame ridge. Any beam, in general, used in a primary frame.
16. **Rod Bracing** - Rods are utilized in conjunction with purlins and girts to form a truss-type bracing system located in both roof and wall planes.
17. **Roof Purlin** - A roof secondary member which is secured to frame rafters and supports the roof covering.
18. **Roof Slope (x:12)** - This is the angle of the roof with respect to the horizontal. The most common roof slopes are 0.5/10 and 1/10. Any practical roof slope is possible.
19. **Roof System** - The exterior roof surface consisting of panels, closures and attachments.
20. **Sidewall** - An exterior wall which is parallel to the ridge and sidewall of the building.
21. **Three-Plate** - A built-up beam section, forming an 'I' shape that consists of 2 flanges and 1 web. Using three-plate over conventional structural shapes allows for greater strength at a reduced weight. These sections are often tapered to optimize performance.
22. **Wall Girt** - A horizontal wall secondary member which is secured to columns and supports the wall covering.

23. **Wall System** - The exterior wall surface consisting of panels, closures and attachments.

Appendix - C

INTERNATIONAL CODES, STANDARDS AND REGULATIONS

There are many standards produced by many different standards-writing bodies. The list of standards referenced below, represents the standards that are applicable in different regions of the world. Since some of those standards may differ from the country to country, it is important for purchasers, installers, and users to know which ones apply for a particular situation.

USA

The primary industry group, CMAA - Crane Manufacturers Association of America, Inc. -- provides standards, specifications, market research initiatives, industry statistics, literature and publications.

CMAA Specification #70, Top Running Double Girder Bridge and Gantry Type Electric Overhead Traveling Cranes

CMAA Specification #74, Top/Under Running Single Girder Electric Traveling Cranes Utilizing Under Running Trolley Hoist

CMAA Specification #78, Standards and Guidelines for Professionals Services Performed On Overhead and Traveling Cranes and Associated Equipment

ASME provides codes and standards, publications, conferences, continuing education and professional development.

ASME - ANSI B30.2, Overhead and Gantry Cranes (Top Running Bridge, Single or Multiple Girder, Top Running Hoist)

ASME - ANSI B30.7, Base Mounted Drum Hoists

ASME - ANSI B30.9, Slings

ASME - ANSI B30.10, Hooks

ASME - ANSI B30.11, Monorails and Underhung Cranes

ASME - ANSI B30.16, Overhead Hoists (Underhung)

ASME - ANSI B30.17, Overhead and Gantry Cranes (Top Running Bridge, Single Girder, Underhung Hoist)

ASME - ANSI B30.20, Below-the-Hook Lifting Devices

ASME - ANSI B30.21, Manually Lever Operated Hoists

The American Welding Society (AWS) is a multifaceted, nonprofit organization to advance the science, technology and application of welding and related joining disciplines.

AWS D1.1, Structural Steel Welding Code

AWS D14.1, Specification for Welding Industrial and Mill Cranes and Other Material Handling Equipment

OSHA (Parts 1910 and 1926) adopts or invokes the American Society of Mechanical Engineers (ASME) HST Performance and B30 Safety Standards for hoists and related equipment.

The Hoist Manufacturers Institute (HMI), which is part of MHIA, provides a variety of Educational Materials, Marketing Information and Standards Development as they relate to hoisting equipment.

Generally, for hoist installations in the US the standards published by the American Society of Mechanical Engineers apply.

CANADA

CSA B167 – closely resembles CMAA.

INTERNATIONAL

Outside North America, ISO (International Organization for Standardization) is sometimes referenced. For certain areas of the Asian markets, the Japanese JIS standards may apply. The following is a selection of ISO and JIS standards applicable to hoists directly or through association with lifting machinery such as cranes:

ISO STANDARDS

The International Organization for Standardization (ISO) (www.iso.ch) publishes many standards for numerous types of lifting machinery; many specifically for application, design, operation and maintenance of cranes. Below is a brief selection applicable to hoists and hoist components:

1. ISO 1837 Lifting Hooks - Nomenclature

2. ISO 2374 Lifting Appliances - Range Of Maximum Capabilities for Basic Models
3. ISO 2408 Steel Wire Rope for General Purposes

JIS STANDARDS

The Japanese Industrial Standards Committee (JIS; website www.jisc.go.jp) publishes standards for hoists. Some of the primary ones are:

1. JIS B 8802 Manually Operated Chain Hoists
2. JIS B 8815 Electric Chain Hoists
3. JIS B 8819 Manually Operated Chain Lever Hoists
4. JIS C 9620 Electric Wire Rope Hoists

EUROPEAN

Traditionally, European countries have maintained national standards in reference to a large number of industrial products, e.g. DIN (Germany), BSI (United Kingdom). In addition the FEM (Federation Europeenne de la Manutention) has published standards specifically for material handling and lifting equipment. With the creation of the European Union, organizations for standardization were established at different levels of regulatory authority covering numerous product areas.

The highest regulatory level is a European Standards Commission. Its regulations are absolute and regulatory, focusing primarily on worker safety and protection from occupational hazards. There are three main regulations:

1. Machinery Regulation (including Lifting and Material Handling Equipment)
2. Low Voltage Electricity Regulation
3. EMV – Electro-magnetic Compatibility Regulation

At the next level are CEN (mechanical) and CENELEC (electrical) Standards. They are more detailed and product oriented than the regulations. Per definition, the publications of CEN and CENELEC are “Standards”, non-regulatory guidelines, reflecting state of the art design and construction practices. They are based on the highest level of probability that equipment, designed to these

standards will be safe and functional. They do not preclude deviations or “product improvement based on technological progress”.

The goal of the CEN & CENELEC Committees is to harmonize the new European norms with existing country-specific norms. The committees responsible for generating new standards include workgroups and sub-committees, which are comprised of representatives of related industries, academia and engineering research, as well as legal counsel. When a new CEN/CENELEC standard is introduced and “HARMONIZED” (language, legal, etc.), national norms (DIN (Germany), BS (England), AFNOR (France), AENOR (Spain), etc.) lose validity.

CEN/CENELEC and ISO maintain communication between their committees working on related subjects.

FEM is an Industry Association of Material Handling Manufacturers, similar in nature and function to MHIA Product Councils (HMI, CMAA, MMA, etc.). FEM specifications are not regulatory, yet they are widely accepted in the international arena, and usually referred to in the absence of national standards.

The following is a listing of European standards and specifications for hoists and related equipment:

BSI STANDARDS

The following is a selection of primary standards published by the British Standards (BSI) (www.bsi-global.com) for hoists and related material handling equipment (BS EN indicates harmonized standard):

1. BS EN 292 Safety of Machinery
2. BS EN 14492-2 Cranes – Power Driven Hoists
3. BS EN 60034-1 Rotating Electrical Machines: Rating and performance
4. BS EN 60034-5 Types of Enclosures for Rotating Electrical Machines
5. BS EN 60204-32 Safety of Machinery - Electrical Equipment of Machines
- Part 32: Requirements for Hoisting Machines

DIN STANDARDS

The following is a selection of primary standards published by the Deutsches Institut für Normung (DIN) (www.din.de) for application, design, maintenance and safety aspects of hoist and related equipment (DIN EN indicates harmonized standard):

1. DIN EN 14492-2 Cranes – Power Driven Hoists
2. DIN EN 60204-32 Safety of Machinery; Electrical Equipment of Machines; Requirements for Hoisting Machines.
3. DIN 3051-Sections 1–4 Lifting Ropes; Steel Wires
4. DIN 15017 Cranes & Hoists; Principles of Motor and Gear Sizing
5. DIN 15020- Sections 1–2 Hoists; Principles of Rope Reeving
6. DIN 15061- Sections 1–2 Cranes & Hoists; Grooves for Rope Sheaves & Drums
7. DIN 15100 Serial Lifting Equipment; Nomenclature
8. DIN 15400 through DIN 15414 Detailed Aspects of Load Hooks and Bottom Block Construction

FEM STANDARDS

The Federation Europeenne de la Manutention (FEM) (www.fem-eur.com) publishes many standards for hoists and related material handling equipment. Some of the primary ones are:

1. FEM 1.002 Illustrated Terminology of Heavy Lifting Equipment
2. FEM 9.811 Rope and Chain Hoists – General Specifications
3. FEM 9.511 Rules for the Design of Series Lifting Equipment - Classification of Mechanisms
4. FEM 9.661 Rules for the design of Series Lifting Equipment - Dimensions and Design of Rope Reeving Components
5. FEM 9.683 Selection of Hoist and Travel Motors
6. FEM 9.852 Power Driven Series Hoist Mechanisms, Standardized Test Procedure for Verification of the Classification

7. FEM 9.755 Measures for Achieving Safe Working Periods for Motorized Serial Hoist Units (S.W.P.)
8. FEM 9.751 Power Driven Series Hoist Mechanisms, Safety
9. FEM 9.901 Rules for the Design of Series Lifting Equipment and Cranes Equipped with Series Lifting Equipment

CEN STANDARDS

The following is a selection of primary standards published by the European Committee for Standardization (CEN) (www.cenorm.be) for hoists and related material handling equipment:

1. EN 341 Cranes – Bridge and Gantry Cranes
2. EN 13135-1 Cranes – Equipment – Part 1: Electrical Equipment
3. EN 13135-2 Cranes – Equipment – Part 2: Non-electrical Equipment
4. EN 13157 Cranes – Safety – Hand Powered Cranes
5. EN 13155 Cranes – Safety – Non-fixed Load Lifting Attachments
6. EN 13557 Cranes – Controls and Control Stations
7. EN 14492-1 Cranes – Power Driven Winches and Hoists – Part 1: Power Driven Winches
8. EN 14492-2 Cranes – Power Driven Winches and Hoists – Part 2: Power Driven Hoists
9. EN 60204-32 Safety of Machinery; Electrical Equipment of Machines; Requirements for Hoisting Machines